



2051nt

**ACC MICRO 2051nt
PENTIUM-CLASS PCI SINGLE CHIP SOLUTION®
FOR NOTEBOOK APPLICATIONS**

**DATA BOOK
ADVANCED INFORMATION**

**JANUARY 1997
Revision 3.0**

ACC Microelectronics Corporation

2500 Augustine Drive,
Santa Clara, CA 95054
Phone: (408) 980-0622 Fax: (408) 980-0626

Copyright 1996 ACC Microelectronics Corporation. All rights reserved.
P/N 520210 Rev. 3.0 January 1997

Copyright

No part of this publication may be reproduced, transmitted, transcribed, stored in a retrieval system, or translated into any language or computer language, in any form or by any means, electronic, mechanical, magnetic, optical, chemical, manual, or otherwise, without the prior written permission of ACC Microelectronics Corp, 2500 Augustine Drive, Santa Clara, CA 95054.

Disclaimer

ACC Microelectronics Corp. makes no representations or warranties with respect to the design and documentation herein described and especially disclaims any implied warranties of merchantability or fitness for any particular purpose. Further, ACC Microelectronics Corp. reserves the right to revise the design and associated documentation and to make changes from time to time in the content without obligation of ACC Microelectronics Corp. to notify any person of such revisions or changes.

Trademarks

Single Chip Solution is registered trademark of ACC Microelectronics Corp.

All other trademarks and copyrights are the property of their respective holders.

Table of Contents

Title	Page
1.0 Introduction	1
1.1 ACC Micro 2051nt PCI Single Chip Solution Description	1
1.2 ACC Micro 2051nt PCI Single Chip Solution Features	1
1.3 ACC Micro 2051nt Block Diagram	3
2.0 Functional Description	4
2.1 L2 Cache	4
2.2 DRAM Interface	4
2.3 PCI Bus	4
2.4 Posted Write/Pre-fetch Buffers	4
2.5 Clock	4
2.6 Power Management Modes	5
2.6.1 Fully-On	5
2.6.2 Standby	5
2.6.3 Suspend	5
2.6.4 Doze	5
2.7 Idle Timers	6
2.7.1 Global-StandBy Timer	6
2.7.2 Auto-Suspend	6
2.7.3 Local-Standby Timers	6
2.7.4 Doze Timers	6
2.7.5 Warning Timers	6
2.8 SMM/SMIs	6
2.9 Thermal Control	7
2.10 Battery Management	7
2.11 AC Power	7
2.12 Mobile PC/PCI	7
2.13 CLKRUN#	7
2.14 Device I/O Shadowing	7
3.0 ACC Micro Pin Specifications	8
3.1 Pin Description	8
Table 3-1 Clock Interface	8
Table 3-2 CPU Interface	8
Table 3-3 Cache Interface	9
Table 3-4 DRAM Interface	11
Table 3-5 PCI Interface	11
Table 3-6 Reset Interface	12
Table 3-7 ISA Interface	12
Table 3-8 ISA/IRQ Interface	13
Table 3-9 ISA/XD Interface	14
Table 3-10 Real time Clock Interface	14
Table 3-11 Address Buffers Decodes Interface	14

Title	Page
Table 3-12 PC/PCI Interface	14
Table 3-13 PMC Interface	15
Table 3-14 Misc. Interface	15
3.2 ACC Micro 2051nt Numerical Pin Arrangement (w/ L2 Cache)	16
3.3 ACC Micro 2051nt Alphabetical Pin Arrangement (w/ L2 Cache)	18
3.4 ACC Micro 2051nt Summary Table for Multiplex Pins	20
3.5 ACC Micro 2051nt Power Plane Summary Table	23
3.6 ACC Micro 2051nt Shadow Register Application	24
4.0 ACC Micro 2051nt Register Settings	26
4.1 Device 0, Function 0 Configuration	27
4.1.1 PCI Range & Control	28
4.1.2 IDE Address	34
4.2 Memory Configuration	36
4.2.1 DRAM Configuration	37
4.2.2 L2 Cache Configuration	43
4.3 Power Management	48
4.3.1 Suspend Control	48
4.3.2 GPIO	50
4.4 Device 1, Function 0 Configuration	51
4.4.1 ISA Configuration	54
4.4.2 Chip Select Functions	57
4.4.3 ISA Peripheral Selection	60
4.5 Device 1, Function 1 Configuration	63
4.5.1 PCI IDE Control	64
4.6 Standard AT Configuration	70
4.6.1 SMI Registers	70
4.6.2 VRAM & Power Control	72
4.6.3 Doze Mode Control	74
4.6.4 Warning Timers	77
4.6.5 General Chip Select	79
4.6.6 Standby Control	84
4.6.7 Suspend Control	90
4.6.8 Battery Low Control	93
4.6.9 Thermal Control Through Software Emulation	96
4.6.10 STOP Clock Control	97
4.7 Interrupt Controller Register	99
4.7.1 IRQ7-IRQ3 Edge/Level Control Register	99
4.7.2 IRQ15-IRQ9 Edge/Level Control Register	100
5.0 ACC Micro 2051nt DC Specifications	101

Title	Page
6.0 ACC Micro 2051nt AC Specifications	104
6.1 Timing Diagrams	104
6.1.1 Propagation Delay	104
6.1.2 Valid Delay from Rising Clock Edge	104
6.1.3 Setup and Hold Times	104
6.1.4 Float Delay	104
6.1.5 Clock High and Low Timers and Period	105
6.1.6 Pulse Width	105
6.1.7 Output to Output Delay	105
6.2 Signals Timing	106
6.2.1 CLOCK Timing	106
6.2.2 CPU Interface Timing	106
6.2.3 Asynchronous Cache Interface Timing	107
6.2.4 Synchronous Cache Interface Timing	107
6.2.5 Fast Page Mode / EDO DRAM Interface Timing	108
6.2.6 PCI Interface Timing	108
6.2.7 AT Interface Timing	109
6.3 Functional Timing Diagram	110
6.3.1 Reset Timing	110
6.3.2 Shutdown Timing	110
6.3.3 AT Bus 16-Bit Access Timing	111
6.3.4 AT Bus 8-Bit Access Timing	112
6.3.5 Fast Page Mode DRAM Access Timing-Read Cycle	112
6.3.6 Fast Page Mode Access Timing-Write Cycle	113
6.3.7 EDO Page-Write Missed Cycle Timing	114
6.3.8 EDO Page-Read Missed Cycle Timing	115
6.3.9 Asynchronous SRAM Burst Read Cycle (3-2-2-2)	117
6.3.10 Asynchronous SRAM Burst Write Cycle (4-2-2-2)	117
6.3.11 Pipeline Synchronous SRAM Burst Read Cycle	118
6.3.12 Pipeline Synchronous SRAM Burst Write Cycle (3-1-1-1)	119
6.3.13 CPU-to-PCI Single Read	120
6.3.14 CPU-to-PCI Single Write, Write Buffer	121
6.3.15 CPU-to-PCI Multiple Write, Write-to-Buffer, PCI Burst Write	122
7.0 ACC Micro 2051nt Pin Diagram	123
7.1.1 ACC Micro 2051nt Pin Side View	123
7.1.2 ACC Micro 2051nt Pin Top View	124
7.1.3 ACC Micro 2051nt Mechanical Data Top View and Side View	125
7.1.4 ACC Micro 2051nt Mechanical Data - Top View	126
7.1.5 Package Dimensions	127

Appendix A-1 List of Sales Representatives

ACC Micro 2051nt PCI Single Chip Solution® for Notebook Applications

Section 1 Introduction

1.1 Description

The ACC Micro 2051nt, PCI Single Chip Solution®, is a true 64-bit high performance notebook solution to support Intel Pentium, Cyrix M1, and AMD K5 microprocessors. The rich feature set of the ACC Micro 2051nt includes: level 2 write-back cache controller, DRAM controller, PCI interface, ISA interface, and ACC Micro Power Management control. The integrated level 2 cache controller supports different types of SRAM such as burst, pipeline burst, or standard asynchronous SRAM. Extended Data Output (EDO, and Fast Page Mode DRAM are supported by the integrated DRAM controller. The built-in PCI bus interface can run in synchronous or asynchronous mode with mobile/PCI support for docking designs.

ACC Micro Power Management allows the system power consumption to be controlled in various operation modes such as Power-on suspend, Power-down suspend, Standby, and Doze. The whole system is partitioned into four different power planes: CPU interface and level 2 cache interface, DRAM interface, PCI bus interface, and ISA bus interface. Every power plane, except ISA (which is always at 5.0V) can be independently configured to either 3.3V or 5.0V. No external level shifter is required.

1.2 Features

- ◆ **Supports Intel P54C, Cyrix M1, and AMD K5**
 - Linear burst support
 - 64-bit Pentium class CPU with 66 MHz bus frequency

- ◆ **ACC Micro Power Management Control**
 - SMM/SMI support
 - Individual sets of system events and break events such as for Global Standby, Local Standby, Suspend, and Doze control.
 - Dedicated external SMI trigger inputs such as for battery monitoring, suspend/resume button, and AC power.
 - Software SMI
 - Warning Timer for SMI
 - Patented '*Adaptive Thermal Control*' with auto-control or SMI generation
 - Shadow Registers for suspend to disk
 - Suspend to DRAM
 - CPU/PCI/ISA individually suspend/powered-down
 - Stop clock protocol, STPCLK#
 - 0 Hz suspend
 - PCI suspend for *Warm Docking*

- ◆ **Mobile PC, or PC/PCI**
 - CLKRUN# protocol to reduce PCI power consumption
 - Serialized interrupt protocol, SIN#/SOUT# for interrupt routing in docking design
 - Serialized DMA protocol for DRQ routing in docking design

2051nt Features (continued)

- ◆ **Synchronous/asynchronous PCI bus**
 - Synchronous PCI clock at CPUCLK/2
 - Asynchronous PCI clock
 - Four PCI bus masters
 - Converts back to back sequential CPU to PCI memory writes to PCI burst writes
 - Bytes merge for CPU to PCI memory write
 - Eight Dwords deep of CPU to PCI posted write buffers
 - Four Dwords pre-fetch buffers for CPU read from PCI memory
 - PCI to DRAM posting 8 Qwords deep
 - PCI from DRAM pre-fetched buffers 4 Qwords deep
 - Pre-snoop capability for PCI to DRAM with bandwidth of 119 MB/s
 - 3V or 5V PCI bus

- ◆ **Built-in DRAM controller**
 - Five banks of DRAM, up to 512MB main memory
 - Self-Refresh DRAM support
 - EDO or Fast Page Mode DRAM
 - Five RAS and 12 MA lines
 - Symmetrical/Asymmetrical DRAMs
 - 64-bit data path to memory
 - 64-bit DRAM option for individual bank
 - Four Qword posted write buffers for x-1-1-1 DRAM write cycles
 - Support 3V or 5V DRAM

- ◆ **Built-in level 2 cache controller**
 - Direct mapped write back/write through
 - Up to 2MB
 - Burst, pipelined burst, or standard SRAM
 - Cache hit read/write x-1-1-1-1 ... with pipelined burst SRAM

- ◆ **Built-in full-blown ISA bus interface**
 - Integrated 8254x1, 8259x2, 8237x2
 - Programmable ISA bus speed
 - Independent edge/level triggered interrupt controller
 - Optional Type-F DMA
 - X-bus support for chip select decode
 - Flash EPROM support
 - Dedicated ISA cycles option to free up the PCI bus

- ◆ **Integrated Fast IDE interface**
 - Enhanced PCI IDE
 - Support master/DMA mode IDE
 - Built-in 8 Dwords posted write buffer
 - Built-in 8 Dwords pre-fetched buffer
 - Four independently programmable register sets for IDE timing control

- ◆ **Built-in 64-bit data path**

1.3 Block Diagram

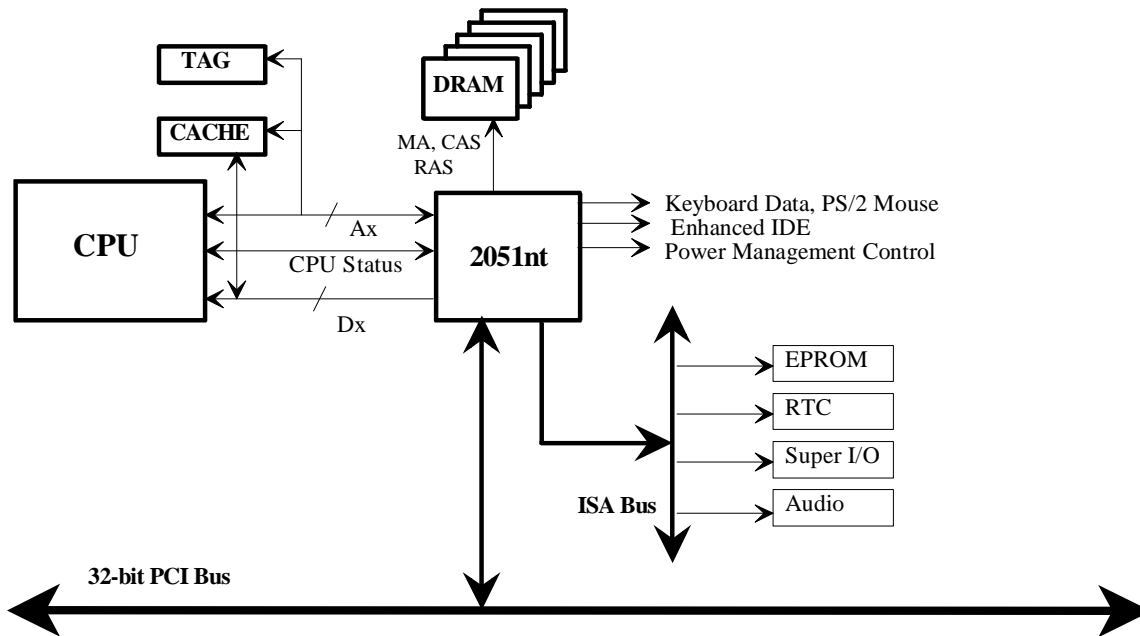

Section 2 Functional Description

2.1 L2 Cache

A direct map level 2 cache controller is incorporated to support up to 2MBytes of SRAM by using either burst, pipelined burst, or standard SRAM. A dynamic write-back/write-through algorithm is implemented to optimize the bandwidth between cache and main memory. Alternatively, a cache hit 3-1-1-1-1-1-1-1 burst transfer can be achieved by using pipelined burst SRAM. Using standard SRAM, 3-2-2-2 cycles can be achieved.

2.2 DRAM Interface

The DRAM controller is optimized to support standard fast page mode and Extended Data Out (EDO). Up to 512MBytes of memory space is supported with 5 RAS and 12 MA lines. Both, symmetrical and asymmetrical addressing DRAMs are supported. The memory data path can be either 32-bit, 64-bit, or mixed.

Four Qwords buffers are implemented to support 3-1-1-1 posted write cycles. With the 60ns EDO DRAM, x-2-2-2 burst read sequence can be achieved at 66 Mhz. A pseudo EDO mode is also available for standard DRAM to achieve the x-3-3-3 burst read sequences.

2.3 PCI Bus

This 32-bit PCI interface with is PCI Rev. 2.0 compliant and can support up to four PCI master devices in addition to the CPU host and the ISA DMA/master requests with either fixed or rotated priority scheme. For CPU initiated write cycles, the PCI controller supports byte/word/Dword merge and will convert sequential write into PCI burst sequence. Pre-fetch functions are also supported for CPU initiated read cycles.

The PCI to DRAM burst access can reach X-1-1-1-1-1-1-1 for 32-bit during both read and write cycles.

2.4 Posted Write/Pre-fetch Buffers

A 4-Qword write buffer is implemented for CPU to main memory writes. Another 4-Qword buffer is also implemented for CPU-to-PCI writes. The PCI pre-fetch buffer and PCI-to-main memory write buffer can operate concurrently. The PCI pre-fetch buffer with the DRAM posted write buffer, forms an 8-Qword buffer to provide for PCI-to-main memory transfer.

2.5 Clock

Both CPU clock (CPUCLKO) and PCI clock (PCICLKO) are derived from one clock source, CLKSRC. In the fully-on mode, CPUCLKO is defined as CLKSRC/1, and the PCICLKO is defined as CLKSRC/2. During operation, both CPUCLKO and PCICLKO may be scaled, modulated, or stopped independently.

2.6 Power Management Modes

ACC Micro Power Management core provides four major power management modes, Fully-On, Standby, Suspend, and Doze. Every mode has its own associated timers and up to 31 different system events can be used as the monitor trigger sources. The transition between Fully-On, Standby, and Suspend are fully programmable through SMI routines and the Doze mode can be enabled during Fully-On as well as Standby mode. Doze mode, once enabled, will dynamically conserve CPU power without system intervention. Dedicated input/output pins are also available to further facilitate the system design, including external SMI inputs, suspend input, power on/off sequencing, etc. This increased flexibility allows system designers to fully customize and diversify their products.

2.6.1 Fully-On

The default condition after power up is Fully-On. The CPU is running at full speed and all the peripherals are powered-up. The Doze function can be enabled from this mode to conserve power when a selected idle condition is detected.

2.6.2 Standby

Standby mode indicates that the system may not need full power, thus can be operated at a lower speed. Additionally, peripheral devices can be selected to be powered down for further power savings. The system can enter this mode when no pre-defined system events occur for a pre-programmed period of time. Any pre-defined break event can bring the system back to the Fully-On mode. Register section 4.6.6 herein shows specific details regarding the programming of the Standby function.

2.6.3 Suspend

Three suspend modes are supported: Freeze, Power-On-Suspend, and the Power-Down-Suspend (Suspend-To-Disk, or 0V-Suspend). In the Freeze mode, all devices are still powered on but will enter individual standby modes and the clocks will be stopped. The complexity of the system design is dramatically reduced since no power plane partitioning or leakage control is required. No data restoration or power-on sequencing is needed since all devices still retain their own contents and provide the fastest resume process. Power-On-Suspend also provides a fast resume process yet consumes minimum power by keeping only the necessary devices powered. Power-hungry devices, such as CPU, SRAM, or some of the peripheral devices can be turned off. Power-Down-Suspend mode will save all the system contents into disk and power down all the devices except the RTC. This mode provides the maximum power savings since very little power is consumed but a longer restart time is required. System designers can implement this mode as the deepest suspend mode, or enable it only when the battery is exhausted. Register section 4.6.7 herein shows specific details regarding the programming of the Suspend function.

2.6.4 Doze

When a CPU idle condition has been detected, the CPU will be put into a low-power consumption state. STPCLK# is asserted and the CPU stays in the STOP-GRANT-STATE. For information of programming the Doze Mode control, refer to register section 4.6.3.

2.7 Idle Timers

2.7.1 Global-StandBy Timer

After a pre-programmed period of time, if no pre-selected system events occur, an SMI is generated. The system designers can decide either to go to conserve mode or go directly into one of the suspend modes. If the Standby mode is used, an Auto-Suspend-Timer can also be set and enabled to force the system into suspend mode after a pre-programmed period of idle time. Any pre-selected break event will generate another SMI to wake up the system.

2.7.2 Auto-Suspend Timer

The Auto-Suspend Timer when programmed and enabled, will generate an SMI if idleness occurs for a programmable period of time.

2.7.3 Local-StandBy Timers

Four timers are available to monitor the peripheral activities, including LCD VRAM, LCD keyboard, general chip select 1, and general chip select 2. The LCD VRAM/keyboard timers monitor the video buffer access and user activities. A proprietary Video-Idle-Filter is incorporated to filter out the real video idleness. General chip select 1 and general chip select 2 timers (GCS [0:1]) can be programmed to monitor access to a specific I/O range.

If no activity is observed during the pre-programmed period of time, SMIs will be generated. Any pre-selected break event occur will generate another SMI if the associated local suspend bit is set.

2.7.4 Doze Timers

Three timers are used to monitor timer tick, system events, and user activities to decide if the CPU is in an idle state.

2.7.5 Warning Timers

All the SMI function except global standby mode, local standby mode, and auto suspend mode, can be qualified with the warning timer to avoid interrupts during other previously requested functions.

2.8 SMM/SMIs

In addition to timer-generated SMIs, both Soft-SMI and External-SMIs are also implemented. Soft-SMIs are activated through software commands. External-SMIs can be generated by a dedicated button/switch or a combination of keystrokes. Those pins include general-purpose SMI inputs, EXTSMI#[0:2], and special-purpose SMI inputs, SRBTN# (Suspend/Resume Button), BATLOW0# (Low Battery), and ACPWR (AC Power).

2.9 Thermal Control

Closed-loop or open-loop thermal control techniques can be used to alleviate temperature problems. An external thermally coupled circuit can be used to automatically enable the built-in clock throttling function. The clock throttling function can also be enabled as an open-loop solution.

ACC Micro's patented Adaptive Thermal Control is embedded in the ACC Micro 2051nt and can be used to eliminate external thermal coupling and provide a pseudo-closed-loop solution. By properly adjusting the high temperature threshold and low threshold, an over-heat warning zone can be defined and the clock throttling function will be automatically enabled when the emulated temperature value falls within this range and is disabled on exit. An SMI can also be generated as an option when entering and exiting the temperature critical zone.

2.10 Battery Management

One battery status pin, BATLOW0# is provided for the battery exhaustion processing.

When BATLOW0# is asserted, SMI# will be asserted after an optionally pre-programmed POWER-LEFT-OVER time. A warning tone can be enabled through the register bit during the SMI routine, or can be set to warn the user of the exhausting battery power before the SMI is issued.

2.11 AC Power

The ACPWR pin can be treated as a special SMI input. SMI# will be asserted when the AC-POWER pin changes state. The power management routine in the BIOS can read the internal registers to know if the ACPWR is in an on or off condition.

2.12 Mobile PC/PCI

PC/PCI protocol is supported to facilitate the mobile docking station design. All the PCI master/grant pairs, INTx#, non-occupied ISA IRQs and DRQs can be programmed to support MHPG architecture.

2.13 CLKRUN#

PCI clock is controlled through PCI CLKRUN protocol. The CLKRUN# pin may be de-asserted and the PCI clock will be stopped if no PCI activities are observed. The PCI clock may be stretched or slowed down for extended cycles.

2.14 Device I/O Shadowing

The PCI-Docking extension (PD) supports the full-blown docking capabilities by providing a PCI-to-PCI and PCI-to-ISA bridge. Alternate devices or I/O ports located on the docking station such as alternate keyboard, RTC, FDC, or RAMDAC can be programmed to be either the primary or secondary functions. The access to the primary functions can be programmed to overshadow the secondary functions.

Section 3.0 Pin Specifications

3.1 2051nt Pin Description

Table 3-1 Clock Interface

Pin Name	Type	Description
CPUCLKI	I	CPU clock input.
KCLK	I	Cache (advance) clock for the cache tag write. KCLK's 3ns - 8ns faster than CPU and Host clocks. Used for Asynchronous SRAM only.
PCICLK0	O	Clock to the CPI device and core logic state machine. This clock should be fed to a separate buffer to provide the clock for core logic and PCI devices.
CPUCLKO	O	It provides the clock to the core logics and CPU. This clock should be fed to a separate buffer to provide the clock for core logics and CPU.
PCICLKI	I	PCI clock input for 2051nt.
CLKSRC	I	System clock source. It is an input clock from the CMOS oscillator or clock chip. CLKSRC provides the clock source for CPUCLKO and PCICLK0.
14M	I	14.318 MHz input clock from external clock source. It is used for AT bus clock reference.
SYSCLK	O	When Standard AT Configuration Register 7h, bit 1 is set to one, it provides the clock to AT bus.
PWR3	I	This is a multifunction pin. As default this pin becomes PWR3 (power control bit 3) for power management function.

Table 3-2 CPU Interface

Pin Name	Type	Description
/ADS	I	/ADS is driven directly by the CPU ADS# pin. It is asserted in T1 of the CPU bus cycle.
M/-IO	I	When high, it indicates current bus cycle is a memory access cycle. It is an I/O cycle when it is low.
D/-C	I	It indicates whether the current bus cycle is a data or control cycle.
W/-R	I	It indicates whether the current bus cycle is a read or write cycle.

Table 3-2 CPU Interface contd...

/BRDY	O	It indicates to the CPU the data for read/write cycle is ready.
/HIT-M	I	Asserted by the CPU to indicate that a snoop cycle has hit a modified line and needs to be written back.
/EADS	O	It indicates a valid external address has been driven onto the processor address pins to be used for an inquiry cycle.
/BOFF	O	It is used to back off the current CPU cycle.
/NA	O	It indicates the system controller is ready to accept a new bus cycle although all data transfers for the current cycle have not yet completed.
/CACHE	I	/CACHE is asserted by the CPU to indicate internal cacheability of the cycle (for read), and to indicate a burst writeback cycle (for write).
/KEN	O	In response to the CACHE#, asserted by the CPU, /KEN is asserted to transform the cycle into a burst line fill cycle.
/LOCK	I	It indicates the current CPU cycle is locked.
/SMIACT	I	It indicates by the CPU that it is in system management mode after /SMI being served by the CPU.
A[3:31]	I/O	These are input during CPU cycles. They become output during snoop cycle.
D[0:63]	I/O	CPU Data bus.
/BE[0:7]	I/O	These are used to indicate which byte lanes the CPU cycle is accessing.
NMI	O	Non-Maskable Interrupt. It connects to the NMI of the CPU.
INTR	O	It indicates a valid interrupt request is asserted.
/A20M	O	Gate A20.
/FERR	I/O	Numeric Coprocessor Error. It indicates a coprocessor error.
/IGNNE	O	Ignore Error.

Table 3-3 Multifunction PMC / Cache Interface (The level 2 cache is disabled as power-on default)

Pin Name	Type	Description
TPWROUT0-6	O	When Register 82h bit 5 is set to 1, the output value for these signals can be programmed through Register 8Ah (device 0 function 0)
TAG0-6	I/O	When level 2 cache is enabled, these signals become TAG0-6. The tag addresses are used to determine if the cycles (read/write) are 22 hit or miss.
PWROUT4	O	When Reg. 8Ah bit 4 is set to 1, this signal becomes PWROUT4 control pin.
TAG7	I/O	When level 2 write back cache is enabled, this pin becomes the dirty bit.

Table 3-3 Multifunction PMC / Cache Interface (The level 2 cache is disabled as power-on default)
 contd...

Pin Name	Type	Description
TPWROUT7	O	When Register 82h bit 5 is set to 1, the output value for this signal can be programmed through Register 8Ah (device 0 function 0)
DTY	I	When level 2 cache is enabled, DTY will write the dirty line back to DRAM.
KCSTS4	I	The value of this status input pin can be read from Register 88h bit 4.
/TAGWE	O	When level 2 cache is enabled, this pin becomes TAG SRAM write enable.
KCSTS0	I	The value of this status input pin can be read from Register 88h bit 0.
/KOE	O	When level 2 cache is enabled, this pin becomes DATA SRAM output enable.
KWSTS0-7	I	The value of this status input pins can be read from Register 89h bit 0-7.
/KWE0-7	O	When level 2 cache is enabled, this pin becomes DATA SRAM write enable.
KCSTS2	I	The value of this status input pin can be read from Register 88h bit 2.
/ADV	O	When Burst SRAM (either pipe or non pipe) is used, this pin becomes Burst SRAM/ADV.
/TKA4	O	When level 2 cache is enabled, and when Asynchronous SRAM is used, this pin becomes burst A4.
KCSTS3	I	The value of this status input pin can be read from Register 88h bit 3.
/ADSC	O	When Burst SRAM (either pipe or non-pipe) is used, this pin becomes Burst SRAM/ADSC.
/TKA3	O	When Asynchronous SRAM is used, it becomes burst A3.
KCSTS1	I	The value of this status input pin can be read from Register 88h bit 1.
/KCS	O	When the L2 cache is enabled, and this pin becomes DATA SRAM chip select.
PWROUT0	I	When Reg. 82h, bit 0 of the PCI configuration register device 0, function 0 is set to one, /KALE becomes power output pin PWROUT0. The value to output to this pin can be programmed from Register 84h bit 0.
/KALE	O	When the L2 cache is enabled, this pin becomes cache address latch enable.

Table 3-4 DRAM Interface

Pin Name	Type	Description
/RAS4-3	O	DRAM row address selection.
PWROUT1-2		When Reg. 82h, of the PCI configuration register device 0, function 0 bits 1-2 are set to one, /RAS4-3 becomes power output pin PWROUT1-2. The value to output to this pin can be programmed from Register 84h bit 1-2.
/RAS2-1	O	DRAM row address selection
/CAS7-0	O	DRAM column address selection.
/WEN	O	DRAM write enable.
MA11-0	O	DRAM row and column address.
MD[0:63]	I/O	Memory data bus.

Table 3-5 PCI Interface

A pull-up resistor to PCI's Vcc is required for PCI interface signals

Pin Name	Type	Description
/FRAME	I/O	It is driven by the current master to indicate the beginning and duration of a transaction. During master cycle, it is an input. It is an output during the CPU cycle.
/TRDY	I/O	It indicates the target device is ready to complete the data transfer. The data transfer is completed when the target is asserting /TRDY and the master is asserting /IRDY at the rising edge of the clock.
/IRDY	I/O	It indicates the initiator is ready for a data transfer.
/STOP	I/O	It indicates the current target is requesting the initiator to stop the current transaction.
/DEVSEL	I/O	As an input, it indicates whether any device on the bus has been selected. It indicates the target device has decoded its address as an output.
PCILOCK	I/O	It is used to prevent multiple access to the same target device at the same time.
AD[31:0]	I/O	PCI AD bus bit 31-0.
PAR	I/O	Parity bit for PCI bus. Parity is asserted one clock after the data phase to ensure even parity across the AD[31:0] and C/BE[7:0].
C/-BE[3:0]	I/O	The state of C/-BE[3:0] indicates which locations in the currently-addressed doubleword are being addressed or the number of additional bytes to transfer.
/REQ[3:0]	I	It indicates PCI master requests for PCI bus.
/GNT[3:0]	O	It indicates the PCI bus is granted to the PCI master per its request.
/CLKRUN	I/O	It is used for mobile PC/PCI serial interrupt protocol to restart the PCI clock if an interrupt received while PCI clock is stopped.
/SERR	I/O	PCI system error. It indicates an address parity / data errors and could cause a NMI to processor or flag an error condition.
/INTA-/INTD	I/O	Interrupt request lines from the PCI devices.

Table 3-6 Reset Interface

Pin Name	Type	Description
PWRGD	SI	Power good signal from system power-good circuitry. It must be stable for at least 1ms. It is used to reset the chip.
RSTDRV	O	It is used to reset the ISA bus devices when the system is powered-up.
CPURST	O	It is used to reset the CPU when the system is powered-up.
INIT	O	INIT asserts to indicate a shutdown special cycle on the PCI bus.
/PCIRST	O	It is used to reset the PCI bus (for hot insertion). Connect /PCIRST to the PCI device's reset pin.

Table 3-7 ISA Interface

Pin Name	Type	Description
SA[16:0]	I/O	System address bus.
LA[23-17]	I/O	Latcheable address bus.
/MASTER	I/O	An input from an active device on the I/O channel. After /MASTER is forced low by an I/O device, the I/O CPU must wait for one system clock period before driving its address and data lines. It should not be held low for more than 15ms as this may result in memory loss due to the lack of a refresh cycle.
BALE	I/O	Indicates a valid address on the SA bus. BALE is used to hold the address during an AT bus cycle
/SBHE	I/O	System bus byte high enable. /SBHE indicates the upper byte transfer (8-bit transfer with an odd address and even address for 16-bit transfer).
PWR4	I	This is a multifunction pin, as default (Reg. 7h bit 3 is set to zero), this pin becomes PWR4 (power control bit 4) for power management function.
/SMEMR	O	When Register 7h bit 3 of the ISA configuration register is set to one and bit 2 equals to 0, it is /SMEMR. It indicates a read cycle is addressed to the lower 1MB memory space.
/PCS2	O	When Register 7h, bit [4,3,2] are set to [1,X,1] it becomes programmable chip select 2 (/PCS2).
PWR2	I	This is a multifunction pin, as default (Reg. 7h bit 0 is set to zero), this pin becomes PWR2 (power control bit 2) for power management function.
/SMEMW	O	When Register 7h, bit 0 of the ISA configuration register is set to one, this pin is /SMEMW. It indicates a write cycle is addressed to the lower 1MB memory space.
/PCS3	O	When Register 7h, bit [4,0] are set to [1,1] it becomes programmable chip select 3 (/PCS3).
/MEMR	I/O	It commands the memory to place valid data on the data bus.
/MEMW	I/O	It commands the memory to accept data from the data bus.
/IOR	I/O	It commands the I/O device to place valid data on the data bus.
/IOW	I/O	Commands the I/O device to accept data from the data bus.
/MCS16	I/O	Enables a 16-bit memory access on the I/O channel.
/IOCS16	I/O	Enables a 16-bit I/O access on the I/O channel.

Table 3-7 ISA Interface contd...

Pin Name	Type	Description
/ZWS	I/O	When an ISA device requires zero wait state, /ZWS will assert. It causes the AT bus cycle to terminate. The zero wait state has no effect during 16-bit I/O cycle.
IOCHK	I/O	Indicates an error condition from an I/O device and causes the system to generate an NMI to CPU.
IOCHRDY	I/O	It causes the wait state(s) to be asserted in I/O or memory accesses.
X32K	I	In suspend mode, this pin can program to become 32KHz clock input for power management module and DRAM refresh state machine.
/REF	I/O	As an input, it causes a refresh cycle from an I/O master device. As an output, it initiates a refresh cycle for the DRAMs.
SD[15:0]	I/O	16-bit System data bus.
DRQ7-0	I/O	DMA request input lines are used by peripherals to obtain DMA service.
TC	O	Transfer completed. DMA controller is actived when the byte or word transfer count for a DMA channel has been exhausted.
/DACK7-0	O	Indicates that DMA service has been granted to the DMA request line by the peripherals.
PWR9-5		These signals are multiplexed with power control bits for power management control signals. When Register 7h, bit 5 of the ISA configuration register is set to one: /DACK7 becomes PWR9 /DACK6 becomes PWR8 /DACK3 becomes PWR7 /DACK1 becomes PWR6 /DACK0 becomes PWR5
AEN	O	Address enable for DMA transfer. It is inactive when an external bus master controls the system bus.

Table 3-8 ISA/IRQ Interface

Pin Name	Type	Description
IRQ1	I/O	When internal keyboard is disabled, Reg. 68h, bit 7 equals zero, this pin is used as IRQ1 input for external keyboard controller (default).
KEYLOCK		When Reg. 68h, bit 7 of the PCI configuration register device 1 function 0 is set to one, internal keyboard is enabled, this pin is the keyboard lock signal.
IRQ3-15	I/O	Interrupt request.
IRQ12	I/O	When internal keyboard is disabled, Reg. 68h, bit 7 equals zero, this pin is an interrupt request line for a PS/2 mouse (default).
MSDATA		When the internal keyboard is enabled, this pin is the mouse data line. (Reg. 68h, bit 7 of the PCI configuration register device 1 function 0 is set to one).

Table 3-9 ISA/XD Interface

Pin Name	Type	Description
/KBCS	I/O	Keyboard chip select (default). When internal keyboard is disabled, Reg. 68h, bit 7 of the PCI configuration register device 1 function 0 equals zero.
MCLK		When internal keyboard is enabled, this pin is the mouse clock.
KBGA20	I/O	When the internal keyboard is disabled, Reg. 68h, bit 7 equals zero, this pin is used as keyboard gate A20 (default).
KBDATA		When Reg. 68h, bit 7 of the PCI configuration register device 1 function 0 is set to one, the internal keyboard is enabled, this pin is the keyboard data.
/KBRST	I/O	When internal keyboard is disabled, Reg. 68h, bit 7 equals zero, this pin is used as keyboard reset (default).
KBCLK		When Reg. 68h, bit 7 of the PCI configuration register device 1 function 0 is set to one, the internal keyboard is enabled, this pin is the keyboard clock.

Table 3-10 Real time Clock Interface

Pin Name	Type	Description
RTCAS	O	Real timer clock address strobe is used to multiplex the bus to an external real time clock plus ram peripheral device.
/RTCWR	O	Real time clock read/write is used to indicate read or write mode for a RTC plus ram device.
/RTCDS	O	Real time clock data strobe is used to control the bi-directional bus on an ext. RTC.

Table 3-11 Address Buffers Decodes Interface

Pin Name	Type	Description
/XDIR	O	It controls the direction of data transfer between the peripheral bus and the I/O channel. When low, it should drive the SD bus signals toward the XD bus. When high, it should drive the XD bus toward the SD bus.
/ROMCS	O	It is used to generate XDIR during ROM read cycle.

Table 3-12 PC/PCI Interface

Pin Name	Type	Description
/SOUT	O	Serial out. Mobile PCI serial interrupt handshaking.
/SIN	I	Serial in. Mobile PCI serial interrupt handshaking.

Table 3-13 PMC Interface

Pin Name	Type	Description
/STPCLK	O	Indicates a request to switch the CPU clock for power management control.
/SMI	O	Causes the processor to enter system management mode once recognized.
PWR0	O	As default, this pin is power control bit 0.
/LTCH0	O	When an external latch is used to support the power controls bit 0-7, this signal will be used to control the 8-bit external latch.
/PCS0	O	When Register 6h, bits 5 and 4 are set to {1:0}, it becomes PCS0, programmable chip select 0.
PWR1	O	As default, this pin is power control bit 1.
/LTCH1	O	When an external latch is used to support the power control bits 8-15, this signal will be used to control the 8-bit external latch.
/DOZE	O	When Register 6h, bit 3 is set to one and bit 2 is set to zero, it indicates that the system is in DOZE mode.
/PCS1	O	When Register 6h, bits 3 and 2 are set to one, it becomes PCS1, programmable chip select bit 1.
/BATLOW0	I	Battery low status pin are provided for the battery exhaustion processing. /SMI will be asserted when /BATLOW0 changes state.
/EXTSMI0-2	I	Three external SMI pins are provided for external devices that required special system handling. /SMI will be asserted when they change state. /EXTSMI0-2 are edge triggered signals and can be programmed to be either rising edge or falling-edge trigger.
/SRBTN	I	Suspend/Resume button can be implemented to put system into suspend mode from normal mode and resume back from suspend mode. An SMI is generated when the button is pressed. /SRBTN is a rising edge trigger.
ACPWR	I	AC Power can be implemented to report system power status. /SMI will be asserted when ACPWR changes state.
/EXTSYS	I	The external system event can be used by external device as a trigger source for break/system event. Core logic will generate SMI once /EXTSYS is triggered. /EXTSYS is an rising edge trigger.
/SUSP	O	/SUSP will be driven out when the system enters the suspend mode.
GPIO0-2, 5-7	I/O	These are general purpose I/O signal. They can set as the output or input by programming Reg. 85h-87h.

Table 3-14 Miscellaneous

Pin Name	Type	Description
SPKR	O	Gates the speaker data and timer 2 to drive the internal speaker.

3.2 2051nt Numerical Pin List (with L2 cache)

Pin #	Pin Name	Pin #	Pin Name	Pin #	Pin Name	Pin #	Pin Name
A1	GND	C3	GND	E5	GND	J25	GND
A2	D16	C4	D11	E6	VCC	J26	/ZWS
A3	D15	C5	D8	E7	GND	J27	DRQ2
A4	D13	C6	D4	E8	VCC	J28	IRQ9
A5	D10	C7	D0	E9	GND	J29	RSTDRV
A6	D6	C8	/KWE5	E10	VCC	K1	D45
A7	D2	C9	/KWE1	E11	TAG0	K2	D44
A8	/KWE7	C10	TAG6	E12	KALE	K3	D43
A9	/KWE3	C11	TAG2	E13	/CACHE	K4	D42
A10	DTY	C12	/TKA4/ADSV#	E14	VDD	K5	VCC
A11	TAG4	C13	/FERR	E15	GND	K25	VCC
A12	/TAGWE	C14	/BRDY	E16	VCC	K26	CLKSRC
A13	/KCS	C15	/LOCK	E17	/BE3	K27	I4M
A14	AHOLD	C16	/HIT-M	E18	CPURST	K28	/SMEMR
A15	/BOFF	C17	/BE1	E19	A16	K29	/SMEMW
A16	DC	C18	/BE6	E20	VCC	L1	D50
A17	/A20M	C19	A18	E21	GND	L2	D49
A18	/BE4	C20	A13	E22	VCC	L3	D48
A19	A20	C21	A5	E23	GND	L4	D47
A20	A15	C22	A6	E24	A22	L5	D46
A21	A9	C23	A29	E25	GND	L25	/DACK1
A22	A8	C24	A26	E26	/IRQ8	L26	DRQ3
A23	A3	C25	A23	E27	/BATLOW0	L27	/DACK3
A24	A28	C26	INIT	E28	/EXTSMI0	L28	/IOR
A25	A24	C27	/SUSP	E29	/EXTSMI1	L29	/IOW
A26	NMI	C28	/EXTSYS	F1	D29	M1	D55
A27	/STPCLK	C29	PWR0	F2	D28	M2	D54
A28	/IDEDACK	D1	D21	F3	D27	M3	D53
A29	GND	D2	D20	F4	D26	M4	D52
B1	GND	D3	D19	F5	VCC	M5	D51
B2	GND	D4	GND	F25	VCC	M25	IRQ4
B3	D14	D5	D7	F26	SPKR	M26	IRQ5
B4	D12	D6	D3	F27	RTCAS	M27	IRQ6
B5	D9	D7	KCLK	F28	/RTCWR	M28	IRQ7
B6	D5	D8	/KWE4	F29	/RTCDS	M29	DRQ1
B7	D1	D9	/KWE0	G1	D33	N1	D60
B8	/KWE6	D10	TAG5	G2	D32	N2	D59
B9	/KWE2	D11	TAG1	G3	D31	N3	D58
B10	TAG7	D12	CPUCLKI	G4	D30	N4	D57
B11	TAG3	D13	MIO	G5	GND	N5	D56
B12	/TKA3/ADSC#	D14	/NA	G25	GND	N25	/MCS16
B13	/KOE	D15	/ADS	G26	/KBRST	N26	BALE
B14	/KEN	D16	WR	G27	SMCLK	N27	TC
B15	/SMIACT	D17	/BE2	G28	SMDATA	N28	/DACK2
B16	/EADS	D18	/BE7	G29	/ROMCS	N29	IRQ3
B17	/BE0	D19	A17	H1	D37	P1	/CAS0
B18	/BE5	D20	A12	H2	D36	P2	D63
B19	A19	D21	A10	H3	D35	P3	D62
B20	A14	D22	A4	H4	D34	P4	D61
B21	A11	D23	A31	H5	VCC	P5	VCC
B22	A7	D24	A27	H25	VCC	P25	VDD
B23	A30	D25	INTR	H26	/XDIR	P26	IRQ12
B24	A25	D26	/IGNNE	H27	IRQ1	P27	IRQ11
B25	A21	D27	/EXTSMI2	H28	/KBCS	P28	IRQ10
B26	/SMI	D28	/SRBTN	H29	KBGA20	P29	/IOCS16
B27	PWRGD	D29	ACPWR	J1	D41	R1	/CAS4
B28	IDEDRQ	E1	D25	J2	D40	R2	/CAS3
B29	PWR1	E2	D24	J3	D39	R3	/CAS2
C1	D18	E3	D23	J4	D38	R4	/CAS1
C2	D17	E4	D22	J5	GND	R5	GND

2051nt Numerical Pin List contd...

Pin #	Pin Name	Pin #	Pin Name	Pin #	Pin Name	Pin #	Pin Name
R25	GND	AA25	GND	AE26	SA14	AG28	SD1
R26	DRQ0	AA26	LA22	AE27	SA13	AG29	SD0
R27	/DACK0	AA27	LA21	AE28	SA12	AH1	MD27
R28	IRQ14	AA28	LA20	AE29	SA11	AH2	MD28
R29	IRQ15	AA29	LA19	AF1	MD24	AH3	MD31
T1	/RAS0	AB1	MD9	AF2	MD23	AH4	MD35
T2	/CAS7	AB2	MD8	AF3	MD22	AH5	MD39
T3	/CAS6	AB3	MD7	AF4	MD33	AH6	MD44
T4	/CAS5	AB4	MD6	AF5	MD37	AH7	MD48
T5	VDD	AB5	VCC	AF6	MD42	AH8	MD52
T25	VCC	AB25	VCC	AF7	MD46	AH9	MD56
T26	DRQ6	AB26	SA1	AF8	MD50	AH10	MD60
T27	/DACK6	AB27	SA0	AF9	MD54	AH11	/TGNT
T28	DRQ5	AB28	/SBHE	AF10	MD58	AH12	AD2
T29	/DACK5	AB29	LA23	AF11	MD63	AH13	AD7
U1	/WEN	AC1	MD13	AF12	AD0	AH14	AD10
U2	/RAS4	AC2	MD12	AF13	AD5	AH15	AD14
U3	/RAS3	AC3	MD11	AF14	AD8	AH16	/SERR
U4	/RAS2	AC4	MD10	AF15	AD12	AH17	/TRDY
U5	/RAS1	AC5	GND	AF16	/CBE1	AH18	AD18
U25	CPUCLKO	AC25	GND	AF17	/DEVSEL	AH19	AD23
U26	PC1CLKO	AC26	SA5	AF18	AD16	AH20	AD26
U27	/MASTER	AC27	SA4	AF19	AD21	AH21	AD29
U28	DRQ7	AC28	SA3	AF20	AD24	AH22	/REQ1
U29	/DACK7	AC29	SA2	AF21	PC1CLKI	AH23	/GNT1
V1	MA4	AD1	MD17	AF22	AD31	AH24	/INTD
V2	MA3	AD2	MD16	AF23	/REQ3	AH25	/SOUT
V3	MA2	AD3	MD15	AF24	/GNT3	AH26	SD7
V4	MA1	AD4	MD14	AF25	/INTB	AH27	SD5
V5	MA0	AD5	VCC	AF26	IOCHRDY	AH28	SD2
V25	SD11	AD25	SA10	AF27	AEN		
V26	SD12	AD26	SA9	AF28	SA16	AJ1	GND
V27	SD13	AD27	SA8	AF29	SA15	AJ2	MD29
V28	SD14	AD28	SA7	AG1	MD26	AJ3	MD32
V29	SD15	AD29	SA6	AG2	MD25	AJ4	MD36
W1	MA9	AE1	MD21	AG3	MD30	AJ5	MD40
W2	MA8	AE2	MD20	AG4	MD34	AJ6	MD45
W3	MA7	AE3	MD19	AG5	MD38	AJ7	MD49
W4	MA6	AE4	MD18	AG6	MD43	AJ8	MD53
W5	MA5	AE5	GND	AG7	MD47	AJ9	MD57
W25	SYSCLK	AE6	MD41	AG8	MD51	AJ10	MD61
W26	/MEMW	AE7	GND	AG9	MD55	AJ11	TPR
W27	SD8	AE8	VCC	AG10	MD59	AJ12	AD3
W28	SD9	AE9	GND	AG11	/TREQ	AJ13	/CBE0
W29	SD10	AE10	VCC	AG12	AD1	AJ14	AD11
Y1	MD1	AE11	MD62	AG13	AD6	AJ15	AD15
Y2	MD0	AE12	/CLKRUN	AG14	AD9	AJ16	/PCILOCK
Y3	MA11	AE13	AD4	AG15	AD13	AJ17	/FRAME
Y4	MA10	AE14	VCC	AG16	PAR	AJ18	AD19
Y5	VCC	AE15	GND	AG17	/TRDY	AJ19	/CBE3
Y25	VCC	AE16	VDD	AG18	AD17	AJ20	AD27
Y26	LA18	AE17	/STOP	AG19	AD22	AJ21	AD30
Y27	LA17	AE18	/CBE2	AG20	AD25	AJ22	/REQ2
Y28	/MEMR	AE19	AD20	AG21	AD28	AJ23	/GNT2
Y29	REF# /32K	AE20	VCC	AG22	/REQ0	AJ24	/INTC
AA1	MD5	AE21	GND	AG23	/GNT0	AJ25	/SIN
AA2	MD4	AE22	VCC	AG24	/PCIRST	AJ26	SD6
AA3	MD3	AE23	GND	AG25	/INTA	AJ27	SD4
AA4	MD2	AE24	VCC	AG26	IOCHCK	AJ28	SD3
AA5	GND	AE25	GND			AJ29	GND

3.3 2051nt Alphabetical Pin List (with L2 cache)

Pin Nam	Pin #	Pin Name	Pin #	Pin Name	Pin #	Pin Name	Pin #
I4M	K27	AD28	AG21	D23	E3	/EXTSMI1	E29
A3	A23	AD29	AH21	D24	E2	/EXTSMI2	D27
A4	D22	AD30	AJ21	D25	E1	/EXTSYS	C28
A5	C21	AD31	AF22	D26	F4	/FERR	C13
A6	C22	/ADS	D15	D27	F3	/FRAME	AJ17
A7	B22	AEN	AF27	D28	F2	/GNT0	AG23
A8	A22	AHOLD	A14	D29	F1	/GNT1	AH23
A9	A21	BALE	N26	D30	G4	/GNT2	AJ23
A10	D21	/BATLOW0	E27	D31	G3	/GNT3	AF24
A11	B21	/BE0	B17	D32	G2	/HIT-M	C16
A12	D20	/BE1	C17	D33	G1	/IDEDACK	A28
A13	C20	/BE2	D17	D34	H4	IDEDRQ	B28
A14	B20	/BE3	E17	D35	H3	/IGNNE	D26
A15	A20	/BE4	A18	D36	H2	INIT	C26
A16	E19	/BE5	B18	D37	H1	/INTA	AG25
A17	D19	/BE6	C18	D38	J4	/INTB	AF25
A18	C19	/BE7	D18	D39	J3	/INTC	AJ24
A19	B19	/BOFF	A15	D40	J2	/INTD	AH24
A20	A19	/BRDY	C14	D41	J1	INTR	D25
A21	B25	/CACHE	E13	D42	K4	IOCHCK	AG26
A22	E24	/CAS0	P1	D43	K3	IOCHRDY	AF26
A23	C25	/CAS1	R4	D44	K2	/IOCS16	P29
A24	A25	/CAS2	R3	D45	K1	/IOR	L28
A25	B24	/CAS3	R2	D46	L5	/IOW	L29
A26	C24	/CAS4	R1	D47	L4	/IRDY	AH17
A27	D24	/CAS5	T4	D48	L3	IRQ1	H27
A28	A24	/CAS6	T3	D49	L2	IRQ3	N29
A29	C23	/CAS7	T2	D50	L1	IRQ4	M25
A30	B23	/CBE0	AJ13	D51	M5	IRQ5	M26
A31	D23	/CBE1	AF16	D52	M4	IRQ6	M27
/A20M	A17	/CBE2	AE18	D53	M3	IRQ7	M28
ACPWR	D29	/CBE3	AJ19	D54	M2	IRQ8	E26
AD0	AF12	/CLKRUN	AE12	D55	M1	IRQ9	J28
AD1	AG12	CLKSRC	K26	D56	N5	IRQ10	P28
AD2	AH12	CPUCLKI	D12	D57	N4	IRQ11	P27
AD3	AJ12	CPUCLKO	U25	D58	N3	IRQ12	P26
AD4	AE13	CPURST	E18	D59	N2	IRQ14	R28
AD5	AF13	D0	C7	D60	N1	IRQ15	R29
AD6	AG13	D1	B7	D61	P4	KALE	E12
AD7	AH13	D2	A7	D62	P3	/KBCS	H28
AD8	AF14	D3	D6	D63	P2	KBGA20	H29
AD9	AG14	D4	C6	/DACK0	R27	/KBRST	G26
AD10	AH14	D5	B6	/DACK1	L25	/KCS	A13
AD11	AJ14	D6	A6	/DACK2	N28	KCLK	D7
AD12	AF15	D7	D5	/DACK3	L27	/KEN	B14
AD13	AG15	D8	C5	/DACK5	T29	/KOE	B13
AD14	AH15	D9	B5	/DACK6	T27	/KWE0	D9
AD15	AJ15	D10	A5	/DACK7	U29	/KWE1	C9
AD16	AF18	D11	C4	DC	A16	/KWE2	B9
AD17	AG18	D12	B4	/DEVSEL	AF17	/KWE3	A9
AD18	AH18	D13	A4	DRQ0	R26	/KWE4	D8
AD19	AJ18	D14	B3	DRQ1	M29	/KWE5	C8
AD20	AE19	D15	A3	DRQ2	J27	/KWE6	B8
AD21	AF19	D16	A2	DRQ3	L26	/KWE7	A8
AD22	AG19	D17	C2	DRQ5	T28	LA17	Y27
AD23	AH19	D18	C1	DRQ6	T26	LA18	Y26
AD24	AF20	D19	D3	DRQ7	U28	LA19	AA29
AD25	AG20	D20	D2	DTY	A10	LA20	AA28
AD26	AH20	D21	D1	/EADS	B16	LA21	AA27
AD27	AJ20	D22	E4	/EXTSMIO	E28	LA22	AA26

2051nt Alphabetical Pin List contd....

Pin Name	Pin #	Pin Name	Pin #	Pin Name	Pin #	Pin Name	Pin #
LA23	AB29	MD41	AE6	SA6	AD29	/TRDY	AG17
/LOCK	C15	MD42	AF6	SA7	AD28	/TREQ	AG11
MA0	V5	MD43	AG6	SA8	AD27	/WEN	U1
MA1	V4	MD44	AH6	SA9	AD26	WR	D16
MA2	V3	MD45	AJ6	SA10	AD25	/XDIR	H26
MA3	V2	MD46	AF7	SA11	AE29	/ZWS	J26
MA4	V1	MD47	AG7	SA12	AE28	GND	A1,A29,B1,
MA5	W5	MD48	AH7	SA13	AE27		B2,C3,D4,
MA6	W4	MD49	AJ7	SA14	AE26		E5,E7,E9,
MA7	W3	MD50	AF8	SA15	AF29		E15,E21,E23,
MA8	W2	MD51	AG8	SA16	AF28		E25,G5,G25,
MA9	W1	MD52	AH8	/SBHE	AB28		J5,J25,R5,
MA10	Y4	MD53	AJ8	SD0	AG29		R25,AA5,
MA11	Y3	MD54	AF9	SD1	AG28		AA25,AC5,
/MASTER	U27	MD55	AG9	SD2	AH28		AC25,AE5,
/MCS16	N25	MD56	AH9	SD3	AJ28		AE7,AE9,
MD0	Y2	MD57	AJ9	SD4	AJ27		AE15,AE21,
MD1	Y1	MD58	AF10	SD5	AH27		AE23,AE25,
MD2	AA4	MD59	AG10	SD6	AJ26		AJ1,AJ29
MD3	AA3	MD60	AH10	SD7	AH26	VCC	E6,E8,E10,
MD4	AA2	MD61	AJ10	SD8	W27		E16,E20,E22,
MD5	AA1	MD62	AE11	SD9	W28		F5,F25,H5,
MD6	AB4	MD63	AF11	SD10	W29		H25,K5,K25,
MD7	AB3	/MEMR	Y28	SD11	V25		P5,T25,Y5,
MD8	AB2	/MEMW	W26	SD12	V26		Y25,AB5,
MD9	AB1	MIO	D13	SD13	V27		AB25,AD5,E8
MD10	AC4	/NA	D14	SD14	V28		AE10,AE14,
MD11	AC3	NMI	A26	SD15	V29		AE20,AE22,
MD12	AC2	PAR	AG16	/SERR	AH16		AE24
MD13	AC1	PCICLKI	AF21	/SIN	AJ25	VDD	E14,P25,
MD14	AD4	PCICLKO	U26	SMCLK	G27		T5,AE16
MD15	AD3	/PCILCK	AJ16	SMDATA	G28		
MD16	AD2	/PCIRST	AG24	/SMEMR	K28		
MD17	AD1	PWRGD	B27	/SMEMW	K29		
MD18	AE4	PWR0	C29	/SMIACT	B15		
MD19	AE3	PWR1	B29	/SMI	B26		
MD20	AE2	/RAS0	T1	/SOUT	AH25		
MD21	AE1	/RAS1	U5	SPKR	F26		
MD22	AF3	/RAS2	U4	/SRBTN	D28		
MD23	AF2	/RAS3	U3	/STOP	AE17		
MD24	AF1	/RAS4	U2	/STPCLK	A27		
MD25	AG2	REF# /32K	Y29	/SUSP	C27		
MD26	AG1	/REQ0	AG22	SYSCCLK	W25		
MD27	AH1	/REQ1	AH22	TAG0	E11		
MD28	AH2	/REQ2	AJ22	TAG1	D11		
MD29	AJ2	/REQ3	AF23	TAG2	C11		
MD30	AG3	RSTDRV	J29	TAG3	B11		
MD31	AH3	RTCAS	F27	TAG4	A11		
MD32	AJ3	/RTCDS	F29	TAG5	D10		
MD33	AF4	/RTCWR	F28	TAG6	C10		
MD34	AG4	/ROMCS	G29	TAG7	B10		
MD35	AH4	SA0	AB27	/TAGWE	A12		
MD36	AJ4	SA1	AB26	TC	N27		
MD37	AF5	SA2	AC29	/TGNT	AH11		
MD38	AG5	SA3	AC28	/TKA3/ADSC#	B12		
MD39	AH5	SA4	AC27	/TKA4/ADSV#	C12		
MD40	AJ5	SA5	AC26	TPR	AJ11		

3.4 Summary Table for ACC Micro 2051nt Multiplex Pins

Pin #	Signal Name	Description	Related Register
B13	/KOE	Cache output enable	When L2 cache is enabled (Reg. 74h, 75h)
	KCSTS0	Status input bit 0	Reg. 88h, bit 0 = 1 & L2 cache disable
A13	/KCS	Cache chip select	When L2 cache is enabled (Reg. 74h, 75h)
	KCSTS1	Status input bit 1	Reg. 88h, bit 1 = 1
E12	KALE	Cache address latch enable	When L2 cache is enabled (Reg. 74h, 75h)
	PWROUT0	Power output bit 0	Reg. 82h, bit 0 = 1
C12	/TKA4	A4 for Asyn. SRAM	Reg. 74h, bit 2 = 1 to select Asyn. SRAM
	/ADSV	For Burst SRAM	Reg. 74h, bit 1 = 1 to select Burst SRAM
	KCSTS2	Status input bit 2	Reg. 88h, bit 2 = 1
B12	/TKA3	A3 for Asyn. SRAM	Reg. 74h, bit 2 = 1 to select Asyn. SRAM
	/ADSC	For Burst SRAM	Reg. 74h, bit 1 = 1 to select Burst SRAM
	KCSTS3	Status input bit 3	Reg. 88h, bit 3 = 1
A12	/TAGWE	Tag write enable	When L2 cache is enabled (Reg. 74h, 75h)
	KCSTS4	Status input bit 4	Reg. 88h, bit 4 = 1
E11	TAG0	Tag bit 0	When L2 cache is enabled (Reg. 74h, 75h)
	TPWROUT0	(Tag) power output bit 0	Reg. 8Ah, bit 0 = 1
D11	TAG1	Tag bit 1	When L2 cache is enabled (Reg. 74h, 75h)
	TPWROUT1	(Tag) power output bit 1	Reg. 8Ah, bit 1 = 1
C11	TAG2	Tag bit 2	When L2 cache is enabled (Reg. 74h, 75h)
	TPWROUT2	(Tag) power output bit 2	Reg. 8Ah, bit 2 = 1
B11	TAG3	Tag bit 3	When L2 cache is enabled (Reg. 74h, 75h)
	TPWROUT3	(Tag) power output bit 3	Reg. 8Ah, bit 3 = 1
A11	TAG4	Tag bit 4	When L2 cache is enabled (Reg. 74h, 75h)
	TPWROUT4	(Tag) power output bit 4	Reg. 8Ah, bit 4 = 1
D10	TAG5	Tag bit 5	When L2 cache is enabled (Reg. 74h, 75h)
	TPWRO5	(Tag) power output bit 5	Reg. 8Ah, bit 5 = 1
C10	TAG6	Tag bit 6	When L2 cache is enabled (Reg. 74h, 75h)
	TPWROUT6	(Tag) power output bit 6	Reg. 8Ah, bit 6 = 1
B10	TAG7	Tag bit 7	When L2 cache is enabled (Reg. 74h, 75h)
	PWROUT4	Power output bit 4	Reg. 82h, bit 4 = 1
A10	DTY	Cache Dirty	When L2 cache is enabled (Reg. 74h, 75h)
	TPWROUT7	(Tag) power output bit 7	Reg. 8Ah, bit 7 = 1
U3	/RAS3	RAS bank 3	Power on default
	PWROUT2	Power output bit 2	Reg. 82h, bit 2 = 1

ACC Micro 2051nt Multiplex Pins contd...

Pin #	Signal Name	Description	Related Register
D9	/KWE0	Cache write enable	When L2 cache is enabled (Reg. 74h, 75h)
	KWSTS0	(Cache) Status input bit 0	Reg. 89h, bit 0 = 1
C9	/KWE1	Cache write enable	When L2 cache is enabled (Reg. 74h, 75h)
	KWSTS1	(Cache) Status input bit 1	Reg. 89h, bit 1 = 1
B9	/KWE2	Cache write enable	When L2 cache is enabled (Reg. 74h, 75h)
	KWSTS2	(Cache) Status input bit 2	Reg. 89h, bit 2 = 1
A9	/KWE3	Cache write enable	When L2 cache is enabled (Reg. 74h, 75h)
	KWSTS3	(Cache) Status input bit 3	Reg. 89h, bit 3 = 1
D8	/KWE4	Cache write enable	When L2 cache is enabled (Reg. 74h, 75h)
	KWSTS4	(Cache) Status input bit 4	Reg. 89h, bit 4 = 1
C8	/KWE5	Cache write enable	When L2 cache is enabled (Reg. 74h, 75h)
	KWSTS5	(Cache) Status input bit 5	Reg. 89h, bit 5 = 1
B8	/KWE6	Cache write enable	When L2 cache is enabled (Reg. 74h, 75h)
	KWSTS6	(Cache) Status input bit 6	Reg. 89h, bit 6 = 1
A8	/KWE7	Cache write enable	When L2 cache is enabled (Reg. 74h, 75h)
	KWSTS7	(Cache) Status input bit 7	Reg. 89h, bit 7 = 1
B29	PWR1	Power output bit 1	Power on default
	/LATCH1	External latch control for PWR8-15	Reg. 6h, bit 3 = 0, Reg. 6h, bit 2 = 1
	/DOZE	Doze pin	Reg. 6h, bit 3 = 1, Reg. 6h, bit 2 = 0
	/PCS1	General chip select bit 2	Reg. 6h, bit 3 = 1, Reg. 6h, bit 2 = 1
C29	PWR0	Power output bit 0	Power on default
	/LATCH0	External latch control for PWR0-7	Reg. 6h, bit 5 = 0, Reg. 6h, bit 4 = 1
	/PCS0	General chip select bit 1	Reg. 6h, bit 5 = 1, Reg. 6h, bit 4 = 0
U29	/DACK7	DMA acknowledge channel 7	Power on default
	PWR9	Power output bit 9	Regi. 7h, bit 5 = 1
T27	/DACK6	DMA acknowledge channel 6	Power on default
	PWR8	Power output bit 8	Reg. 7h, bit 5 = 1
R27	/DACK0	DMA acknowledge channel 0	Power on default
	PWR5	Power output bit 5	Reg. 7h, bit 5 = 1
P26	IRQ12	Interrupt 12	Power on default
	MSDATA	Mouse data	Reg. 68h, bit 7 = 1
L25	/DACK1	DMA acknowledge channel 1	Power on default
	PWR6	Power output bit 6	Reg. 7h, bit 5 = 1
L27	/DACK3	DMA acknowledge channel 3	Power on default
	PWR7	Power output bit 7	Reg. 7h, bit 5 = 1

ACC Micro 2051nt Multiplex Pins contd...

Pin #	Signal Name	Description	Related Register
K28	PWR4	Power output bit 4	Power on default Reg. 7h bit 4 = x, bit 3 = x, bit 2 = 0.
	/SMEMR	System memory read	Reg. 7h, bit 4 = 0, bit 3 = 1, bit 2 = 1.
	/PCS2	Programmable chip select 2	Reg. 7h, bit 4 = 1, bit 3 = 0, bit 2 = 1..
K29	PWR2	Power output bit 2	Power on default. Reg. 7h bit 4 = x, bit 0 = 0.
	/SMEMW	System memory write	Reg. 7h, bit 4 = 0, bit 0 = 1.
	/PCS3	Programmable chip select 3	Reg. 7h, bit 4 = 1, bit 0 = 1.
H27	IRQ1	Interrupt 1	Power on default
	/KEYLOCK	Keylock	Reg. 68h, bit 7 = 1
H28	/KBCS	Keyboard chip select	Power on default
	MSCLK	Mouse clock	Reg. 68h, bit 7 = 1
H29	KBGA20	Keyboard GA20	Power on default
	KBDATA	Keyboard data	Reg. 68h, bit 7 = 1
G26	/KBRST	Keyboard reset	Power on default
	KBCLK	Keyboard clock	Reg. 68h, bit 7 = 1
W25	PWR3	Power output bit 3	Power on default
	SYSCLK	System clock	Reg. 7h, bit 1 = 1
U2	/RAS4	RAS bank 4	Power on default
	PWROUT1	Power output bit 1	Reg. 82h, bit 1 = 1
Y29	X32K	32KHz Clock Source	Reg. 81h, bit 7 = 1
	/REF	DRAM refresh	Power on default
A28	/IDEDACK	IDE master	Reserved.
	PWROUT3	Power out bit 3	Reserved. Power on default
AG11	/TREQ	UMA protocol	Reserved.
	GPIO0	General purpose I/O	Power on default
AH11	/TGNT	UMA protocol	Reserved.
	GPIO1	General purpose I/O	Power on default
AJ11	TPR	UMA protocol	Reserved.
	GPIO2	General purpose I/O	Power on default
G28	SMDATA	SM Bus	Reserved
	GPIO5		Power on default
G27	SMCLK	SM Bus	Reserved
	GPIO6		Power on default
B28	IDEDRQ	IDE master	Reserved.
	GPIO7	General purpose I/O	Reserved. Power on default

3.5 ACC Micro 2051nt Power Plane Summary Table

VCC Pin Number	VCC	Signal Group	Pin Names
E6, E8, E10, E16, E20, E22, F5, H5, K5, P5	3.3V / 5.0V	CPU, Cache	D0-63, /STPCLK, /IGNNE, INIT, /SMI, NMI, INTR, A3-31, CPURST, /BE0-7, /A20M, WR, /HIT-M, /EADS, DC, /ADS, /LOCK, /SMIACT, /BOFF, /NA, /BRDY, /KEN, AHOLD, /CACHE, MIO, /FERR, /KOE, /KCS, KALE, CPUCLKI, /TKA4, TKA3, /TAGWE, TAG0-7, DTY, /KWE0-7, KCLK
Y5, AB5, AD5, AE8, AE10,	3.3V / 5.0V	DRAM	/CAS0-7, /RAS0-7, MA0-11MD0-63,
AE14, AE20, AE22, AE24	3.3V / 5.0V	PCI	GPIO0-2, /CLKRUN, AD0-31, /CBE0-3, PAR, /SERR, /PCILOCK, /STOP, /DEVSEL, /TRDY, /IRDY, /FRAME, /REQ0-3, /GNT0-3, /PCIRST, /INTA-D, /SOUT, /SIN
F25, H25, K25, T25, Y25, AB25	3.3V / 5.0V	ISA, PMC	IOCHCK, SD0-15, IOCHRDY, AEN, SA0-16, /SBHE, LA17-23, /MEMR, REF#/32K, SYSCLK, /MEMW, CPUCLKO, PCICLKO, /MASTER, /DACK0-3, /DACK5-7, DRQ0-3, DRQ5-7, IRQ1, IRQ3-12, IRQ14-15, /IOCS16, /MCS16, BALE, TC, /IOR, /IOW, CLKSRC, 14M, /SMEMR, /SMEMW, /ZWS, RSTDRV, /XDIR, /KBCS, KBGA20, /KBRST, SMCLK, SMDATA, /ROMCS, SPKR, RTCAS, /RTCWR, /RTCDS, /BATLOW0, /EXTSMI0-2, /SRBTN, ACPWR, /EXTSYS, PWROUT0, PWROUT1, IDEDRQ, /IDEDACK, /SUSP, PWRGD
N15, P14-P16, R13-R17, T14-T16, U15		Thermal Grounding	GND

3.6 Shadow Register Application

The ACC Micro 2051nt Shadow Registers are readable and writeable to support Intel SL type of shadow register. In addition, the ACC Micro 2051nt F2 register is readable to further support the power saving feature of the ACC Micro 2051nt. Through the shadow registers, the ACC Micro 2051nt can be powered off and its current state can be suspended to disk. Thus, the device can then be powered back on to the same state as before the last power off. This suspend and resume capability minimizes the system's battery power consumption and thus enhances its power management capabilities.

The ACC Micro 2051nt Shadow Registers and its description are listed as below:

- 1) All the ACC Micro 2051nt Shadow Registers are originally Write-Only in ISA standard. The shadow mechanism makes them readable through the 0F2h and 0F3h indexing scheme.
- 2) For some DMA registers that contain two bytes but have only one index assigned, the following sequence is recommended:

```

CLI                ; Ensure the sequence would not be broken

OUT  0F2h,  INDX  ; Output index, clear the byte pointer, point to low byte

MOV  Ah,  AL     ; Save it to somewhere

IN   AL,  0F3h   ; High byte, byte pointer will not change stay at high byte

```

Note: Any write to 0F2h with index 0Axh will clear the byte pointer which will set pointer to low byte.

The first read from 0F3h after writing the index will set the pointer to high byte. Only one byte pointer is shared by all paired register sets. The first read from 0F3h will return the low byte and the second read will return the high byte.

- 3) For those registers that do not use all the bits, the status of unused bits is reserved. Software needs to mask out these bits when they are restored.
- 4) For DMA base address registers, word count registers, channel mode registers and channel mask registers, the values read back from the shadow registers are the original values loaded.
- 5) The values read back from shadow registers for the timer count are the original values loaded.

ACC Micro 2051nt Shadow Registers Summary

Register Name	SL Mnemonic	Original Address	Index	Comment
DMA CH0 Base Address	SHDMA0BA	00H	0A0H	2 bytes
DMA CH0 Count	SHDMA0WC	01h	0A1h	2 bytes
DMA CH1 Base Address	SHDMA1BA	02h	0A2h	2 bytes
DMA CH1 Count	SHDMA1WC	03h	0A3h	2 bytes
DMA CH2 Base Address	SHDMA2BA	04h	0A4h	2 bytes
DMA CH2 Count	SHDMA2WC	05h	0A5h	2 bytes
DMA CH3 Base Address	SHDMA3BA	06h	0A6h	2 bytes
DMA CH3 Count	SHDMA3WC	07h	0A7h	2 bytes
DMA CH0 Mode	SHDMA0MOD	0Bh	0C0h	1 byte
DMA CH1 Mode	SHDMA1MOD	0Bh	0C1h	1 byte
DMA CH2 Mode	SHDMA2MOD	0Bh	0C2h	1 byte
DMA CH3 Mode	SHDMA3MOD	0Bh	0C3h	1 byte
DMA CNTLR 1 Mask Reg.	SHDMAMSK1	0Fh	0C4h	1 byte
PIC1 ICW2	SHINT1ICW2	21h	0D0h	1 byte
PIC1 ICW4	SHINT1ICW4	21h	0D1h	1 byte
PIC1 OCW3	SHINT1OCW3	20h	0D2h	1 byte
NMI Mask & RTC index	SHNMIMASK	70h	0D6h	1 byte
TMR 1 CNTR 0 cnt low	SHT1CH0CL	40h	0CAh	1 byte
TMR 1 CNTR 0 cnt high	SHT1CH0CH	40h	0CBh	1 byte
TMR 1 CNTR 1 cnt low	SHT1CH1CL	41h	0CCh	1 byte
TMR 1 CNTR 1 cnt high	SHT1CH1CH	41h	0CDh	1 byte
TMR 1 CNTR 2 cnt low	SHT1CH2CL	42h	0CEh	1 byte
TMR 1 CNTR 2 cnt high	SHT1CH2CH	42h	0CFh	1 byte
DMA CH4 Base Address	SHDMA4BA	0C0h	0A8h	2 bytes
DMA CH4 Count	SHDMA4WC	0C2h	0A9h	2 bytes
DMA CH5 Base Address	SHDMA5BA	0C4h	0AAh	2 bytes
DMA CH5 Count	SHDMA5WC	0C6h	0ABh	2 bytes
DMA CH6 Base Address	SHDMA6BA	0C8h	0ACh	2 bytes
DMA CH6 Count	SHDMA6WC	0CAh	0ADh	2 bytes
DMA CH7 Base Address	SHDMA7BA	0CCh	0AEh	2 bytes
DMA CH7 Count	SHDMA7WC	0CEh	0AFh	2 bytes
DMA CH4 Mode	SHDMA4MOD	0D6h	0C5h	1 byte
DMA CH5 Mode	SHDMA5MOD	0D6h	0C6h	1 byte
DMA CH6 Mode	SHDMA6MOD	0D6h	0C7h	1 byte
DMA CH7 Mode	SHDMA7MOD	0D6h	0C8h	1 byte
DMA CNTLR 2 Mask Reg.	SHDMAMSK2	0DEh	0C9h	1 byte
PIC2 ICW2	SHINT2ICW2	0A1h	0D3h	1 byte
PIC2 ICW4	SHINT2ICW4	0A1h	0D4h	1 byte
PIC2 OCW3	SHINT2OCW3	0A0h	0D5h	1 byte

Section 4.0 2051nt Register Settings

The ACC Micro 2051nt internal registers can be accessed through the PCI configuration space and standard AT configuration space. The integrated CPU, PCI, Cache, DRAM, and ISA control functions are fully programmable through these internal configuration registers.

I) PCI Configuration Register:

The PCI configuration space is divided into three functions: the device 0 function 0, the device 1 function 0, and the device 1 function 1 configuration registers.

The device 0, function 0 contains standard PCI port registers, CPU interface registers, cache control registers, DRAM control registers, PCI clock, and power management control registers. These registers are accessible by the host CPU. The first DWORD location (CF8h) references a CONFIG_ADDRESS read/write register. The second DWORD address (CFCh) references a CONFIG_DATA register. To access these internal registers, write a value into CONFIG_ADDRESS that specifies the PCI bus, device on that bus, and configuration register in that device being accessed. A read or write to the device 0, function 0 configuration registers will not appear in the PCI bus cycle.

The device 1, function 0 contains PCI to ISA configuration registers and the device 1, function 1 contains the IDE interface configuration registers. These registers are accessible by the host CPU. The first DWORD location (CF8h) references a CONFIG_ADDRESS read/write register. The second DWORD address (CFCh) references a CONFIG_DATA register. To access these internal registers, write a value into CONFIG_ADDRESS that specifies the PCI bus, device on that bus, and configuration register in the device being accessed. A read or write to CONFIG_DATA will then access the registers being specified.

II) Standard AT Configuration Register:

The standard AT configuration register contains complete power management control registers. These registers are programmed with an indirect addressing scheme using I/O addresses F2 and F3. F2 selects the corresponding configuration register accessed at I/O address F3. For example, to write a value of "E8" into configuration 1h, the index register at I/O address F2 must first be written with a value of "1h," then register at I/O address F3 with a value of "E8".

4.1 Device 0, Function 0 Configuration Registers:**Standard PCI Ports****Vendor ID Register 0h, 1h**

Bit	R/W	Default	Function
15-0	R	10AA	ACC Micro vendor identification

Device ID Register 2h, 3h

Bit	R/W	Default	Function
15-0	R	2051nt	ACC Micro device identification

PCI Command Register 4h, 5h

Bit	R/W	Default	Function
15-0	R	0004	PCI local bus specification command register. (bits 0, 14 = R/W)

PCI Status Register 6h, 7h

Bit	R/W	Default	Function
15-0	R	2200	PCI local bus specification status register. (bits 10-15 = R/W)

PCI Revision ID Register 8h

Bit	R/W	Default	Function
7-0	R	00	PCI local bus specification revision ID register, default 00 code indicates a Host bridge.

Cache Code ID Register 9h, Ah, Bh

Bit	R/W	Default	Function
22-0	R	060000	PCI local bus specification class code register, default 060000 code indicates a bridge device.

Cache Line Size Register Ch

Bit	R/W	Default	Function
7-0	R	00	PCI local bus specification cache line size register

Latency Timer Register Dh

Bit	R/W	Default	Function
7-0	R/W	00	8-bit register that controls data burst time on the PCI bus. Default value is 00 or PCI clock cycles.

Header Type Register Eh

Bit	R/W	Default	Function
7-0	R	00	PCI local bus specification header type register

BIST Register Fh

Bit	R/W	Default	Function
7-0	R	00	Reserved for PCI local bus built-in self test (BIST)

PCI Specification Register 10h - 3Fh

Bit	R/W	Default	Function
7-0	R	00	Reserved for PCI local bus specification

4.1.1 Wait State Control for CPU and PCI Cycle (Registers 40h-43h)**Register 40h**

Bit	R/W	Default	Function
7-3	R	0	Not used.
2	R/W	0	When set to one a wait state will be asserted between successive /IRDY in CPU to PCI cycle.
1	R/W	0	When set to one the CPU to PCI /FRAME will be delayed by one PCI clock.
0	R/W	0	When set to one the first CPU to PCI /IRDY will be delayed by one PCI clock.

Register 41h

Bit	R/W	Default	Function
7	R	1	Reserved.
6	R/W		When set to one a wait state will be added to the 16-bit data following the first 16-bit word during a CPU read.
5	R	1	Reserved.
4	R/W	1	When set to one a wait state will be added to the lead off cycle for the first 16-bit word during a CPU read.
3	R	1	Reserved.
2	R/W	1	When set to one a wait state will be added to the 16-bit word following the first 16-bit word during a CPU write.
1	R	1	Reserved.
0	R/W	1	When set to one a wait state will be added to the lead off cycle for the first 16-bit word during a CPU write.

Register 42h

Bit	R/W	Default	Function
7-5	R	0	Reserved. A zero will be returned if it is read.
4	R/W	0	When set to one the /NA signal will be asserted into the CPU to PCI cycle.
3	R/W	0	When set to one the /NA signal will be asserted at the second T2 to guarantee an appropriate sample period for any CPU to PCI cycle. If set to zero, /NA will be asserted during the first T2.
2	R	0	Reserved. A zero will be returned if it is read.
1	R/W	0	Set to one to enable byte merge mode.
0	R/W	1	When set to one a wait state will be added to the last 16-bit word during a CPU read.

Register 43h

Bit	R/W	Default	Function
7-0	R	0	Reserved. A zero will be returned when these bits are read.

PCI Prefetch Range and Control Registers (44h - 49h)**PCI Prefetch Range Size (Registers 44h, 45h)****Register 44h**

Bit	R/W	Default	Function
7	R/W	0	This bit when set to one selects the base address A23 for prefetch range 0.
6	R/W	0	This bit when set to one selects the base address A22 for prefetch range 0.
5	R/W	0	This bit when set to one selects the base address A21 for prefetch range 0.
4	R/W	0	This bit when set to one selects the base address A20 for prefetch range 0.
3	R/W	0	This bit when set to one selects the base address A19 for prefetch range 0.
2	R/W	0	This bit when set to one selects the base address A18 for prefetch range 0.
1	R/W	0	This bit when set to one selects the base address A17 for prefetch range 0.
0	R/W	0	This bit when set to one selects the base address A16 for prefetch range 0.

Register 45h

Bit	R/W	Default	Function
7	R/W	0	This bit when set to one selects the base address A31 for prefetch range 0.
6	R/W	0	This bit when set to one selects the base address A30 for prefetch range 0.
5	R/W	0	This bit when set to one selects the base address A29 for prefetch range 0.
4	R/W	0	This bit when set to one selects the base address A28 for prefetch range 0.
3	R/W	0	This bit when set to one selects the base address A27 for prefetch range 0.
2	R/W	0	This bit when set to one selects the base address A26 for prefetch range 0.
1	R/W	0	This bit when set to one selects the base address A25 for prefetch range 0.
0	R/W	0	This bit when set to one selects the base address A24 for prefetch range 0.

PCI Prefetch Range Size 1 (Registers 46h, 47h)**Register 46h**

Bit	R/W	Default	Function
7	R/W	0	This bit when set to one selects the base address A23 for prefetch range 1.
6	R/W	0	This bit when set to one selects the base address A22 for prefetch range 1.
5	R/W	0	This bit when set to one selects the base address A21 for prefetch range 1.
4	R/W	0	This bit when set to one selects the base address A20 for prefetch range 1.
3	R/W	0	This bit when set to one selects the base address A19 for prefetch range 1.
2	R/W	0	This bit when set to one selects the base address A18 for prefetch range 1.
1	R/W	0	This bit when set to one selects the base address A17 for prefetch range 1.
0	R/W	0	This bit when set to one selects the base address A16 for prefetch range 1.

Register 47h

Bit	R/W	Default	Function
7	R/W	0	This bit when set to one selects the base address A31 for prefetch range 1.
6	R/W	0	This bit when set to one selects the base address A30 for prefetch range 1.
5	R/W	0	This bit when set to one selects the base address A29 for prefetch range 1.
4	R/W	0	This bit when set to one selects the base address A28 for prefetch range 1.
3	R/W	0	This bit when set to one selects the base address A27 for prefetch range 1.
2	R/W	0	This bit when set to one selects the base address A26 for prefetch range 1.
1	R/W	0	This bit when set to one selects the base address A25 for prefetch range 1.
0	R/W	0	This bit when set to one selects the base address A24 for prefetch range 1.

PCI Prefetch Range 0 Selection Register 48h

Bit	R/W	Default	Function																																																															
7	R/W	0	When set to one, segment A0000h and B0000h will be selected as the prefetch range.																																																															
6-5	R	0	Reserved. A zero will be returned when these bits are read.																																																															
4-0	R/W	00000	<p>Prefetch size for range 0.</p> <table border="1"> <thead> <tr> <th>Bits</th> <th>Address Range</th> <th>Prefetch Size</th> </tr> </thead> <tbody> <tr> <td>43210</td> <td></td> <td></td> </tr> <tr> <td>00000</td> <td>don't care</td> <td>Prefetchable range disabled (default).</td> </tr> <tr> <td>00001</td> <td>A16-A31</td> <td>64K</td> </tr> <tr> <td>00010</td> <td>A17-A31</td> <td>128K</td> </tr> <tr> <td>00011</td> <td>A18-A31</td> <td>256K</td> </tr> <tr> <td>00100</td> <td>A19-A31</td> <td>512K</td> </tr> <tr> <td>00101</td> <td>A20-A31</td> <td>1M</td> </tr> <tr> <td>00110</td> <td>A21-A31</td> <td>2M</td> </tr> <tr> <td>00111</td> <td>A22-A31</td> <td>4M</td> </tr> <tr> <td>01000</td> <td>A23-A31</td> <td>8M</td> </tr> <tr> <td>01001</td> <td>A24-A31</td> <td>16M</td> </tr> <tr> <td>01010</td> <td>A25-A31</td> <td>32M</td> </tr> <tr> <td>01011</td> <td>A26-A31</td> <td>64M</td> </tr> <tr> <td>01100</td> <td>A27-A31</td> <td>128M</td> </tr> <tr> <td>01101</td> <td>A28-A31</td> <td>256M</td> </tr> <tr> <td>01110</td> <td>A29-A31</td> <td>512M</td> </tr> <tr> <td>01111</td> <td>A30-A31</td> <td>1G</td> </tr> <tr> <td>10000</td> <td>A31</td> <td>2G</td> </tr> <tr> <td>10001</td> <td></td> <td>All range prefetchable</td> </tr> <tr> <td>others</td> <td></td> <td>Undefined</td> </tr> </tbody> </table>	Bits	Address Range	Prefetch Size	43210			00000	don't care	Prefetchable range disabled (default).	00001	A16-A31	64K	00010	A17-A31	128K	00011	A18-A31	256K	00100	A19-A31	512K	00101	A20-A31	1M	00110	A21-A31	2M	00111	A22-A31	4M	01000	A23-A31	8M	01001	A24-A31	16M	01010	A25-A31	32M	01011	A26-A31	64M	01100	A27-A31	128M	01101	A28-A31	256M	01110	A29-A31	512M	01111	A30-A31	1G	10000	A31	2G	10001		All range prefetchable	others		Undefined
Bits	Address Range	Prefetch Size																																																																
43210																																																																		
00000	don't care	Prefetchable range disabled (default).																																																																
00001	A16-A31	64K																																																																
00010	A17-A31	128K																																																																
00011	A18-A31	256K																																																																
00100	A19-A31	512K																																																																
00101	A20-A31	1M																																																																
00110	A21-A31	2M																																																																
00111	A22-A31	4M																																																																
01000	A23-A31	8M																																																																
01001	A24-A31	16M																																																																
01010	A25-A31	32M																																																																
01011	A26-A31	64M																																																																
01100	A27-A31	128M																																																																
01101	A28-A31	256M																																																																
01110	A29-A31	512M																																																																
01111	A30-A31	1G																																																																
10000	A31	2G																																																																
10001		All range prefetchable																																																																
others		Undefined																																																																

PCI Prefetch Range 1 Selection Register 49h

Bit	R/W	Default	Function																																																															
7-5	R	0	Reserved. A zero will be returned when these bits are read.																																																															
4-0	R/W	00000	<p>Prefetch size for range 1.</p> <table border="1"> <thead> <tr> <th>Bits</th> <th>Address Compared</th> <th>Prefetch Size</th> </tr> </thead> <tbody> <tr> <td>43210</td> <td></td> <td></td> </tr> <tr> <td>00000</td> <td>don't care</td> <td>Prefetchable range disabled (default).</td> </tr> <tr> <td>00001</td> <td>A16-A31</td> <td>64K</td> </tr> <tr> <td>00010</td> <td>A17-A31</td> <td>128K</td> </tr> <tr> <td>00011</td> <td>A18-A31</td> <td>256K</td> </tr> <tr> <td>00100</td> <td>A19-A31</td> <td>512K</td> </tr> <tr> <td>00101</td> <td>A20-A31</td> <td>1M</td> </tr> <tr> <td>00110</td> <td>A21-A31</td> <td>2M</td> </tr> <tr> <td>00111</td> <td>A22-A31</td> <td>4M</td> </tr> <tr> <td>01000</td> <td>A23-A31</td> <td>8M</td> </tr> <tr> <td>01001</td> <td>A24-A31</td> <td>16M</td> </tr> <tr> <td>01010</td> <td>A25-A31</td> <td>32M</td> </tr> <tr> <td>01011</td> <td>A26-A31</td> <td>64M</td> </tr> <tr> <td>01100</td> <td>A27-A31</td> <td>128M</td> </tr> <tr> <td>01101</td> <td>A28-A31</td> <td>256M</td> </tr> <tr> <td>01110</td> <td>A29-A31</td> <td>512M</td> </tr> <tr> <td>01111</td> <td>A30-A31</td> <td>1G</td> </tr> <tr> <td>10000</td> <td>A31</td> <td>2G</td> </tr> <tr> <td>10001</td> <td></td> <td>All range prefetchable</td> </tr> <tr> <td>others</td> <td></td> <td>Undefined</td> </tr> </tbody> </table>	Bits	Address Compared	Prefetch Size	43210			00000	don't care	Prefetchable range disabled (default).	00001	A16-A31	64K	00010	A17-A31	128K	00011	A18-A31	256K	00100	A19-A31	512K	00101	A20-A31	1M	00110	A21-A31	2M	00111	A22-A31	4M	01000	A23-A31	8M	01001	A24-A31	16M	01010	A25-A31	32M	01011	A26-A31	64M	01100	A27-A31	128M	01101	A28-A31	256M	01110	A29-A31	512M	01111	A30-A31	1G	10000	A31	2G	10001		All range prefetchable	others		Undefined
Bits	Address Compared	Prefetch Size																																																																
43210																																																																		
00000	don't care	Prefetchable range disabled (default).																																																																
00001	A16-A31	64K																																																																
00010	A17-A31	128K																																																																
00011	A18-A31	256K																																																																
00100	A19-A31	512K																																																																
00101	A20-A31	1M																																																																
00110	A21-A31	2M																																																																
00111	A22-A31	4M																																																																
01000	A23-A31	8M																																																																
01001	A24-A31	16M																																																																
01010	A25-A31	32M																																																																
01011	A26-A31	64M																																																																
01100	A27-A31	128M																																																																
01101	A28-A31	256M																																																																
01110	A29-A31	512M																																																																
01111	A30-A31	1G																																																																
10000	A31	2G																																																																
10001		All range prefetchable																																																																
others		Undefined																																																																

PCI Post Write Range 0 (Registers 4Ch, 4Dh)

Register 4Ch

Bit	R/W	Default	Function
7	R/W	0	This bit when set to one selects the base address A23 for post write range 0.
6	R/W	0	This bit when set to one selects the base address A22 for post write range 0.
5	R/W	0	This bit when set to one selects the base address A21 for post write range 0.
4	R/W	0	This bit when set to one selects the base address A20 for post write range 0.
3	R/W	0	This bit when set to one selects the base address A19 for post write range 0.
2	R/W	0	This bit when set to one selects the base address A18 for post write range 0.
1	R/W	0	This bit when set to one selects the base address A17 for post write range 0.
0	R/W	0	This bit when set to one selects the base address A16 for post write range 0.

Register 4Dh

Bit	R/W	Default	Function
7	R/W	0	This bit when set to one selects the base address A31 for post write range 0.
6	R/W	0	This bit when set to one selects the base address A30 for post write range 0.
5	R/W	0	This bit when set to one selects the base address A29 for post write range 0.
4	R/W	0	This bit when set to one selects the base address A28 for post write range 0.
3	R/W	0	This bit when set to one selects the base address A27 for post write range 0.
2	R/W	0	This bit when set to one selects the base address A26 for post write range 0.
1	R/W	0	This bit when set to one selects the base address A25 for post write range 0.
0	R/W	0	This bit when set to one selects the base address A24 for post write range 0.

PCI Post Write Range 1 (Registers 4Eh, 4Fh)**Register 4Eh**

Bit	R/W	Default	Function
7	R/W	0	This bit when set to one selects the base address A23 for post write range 1.
6	R/W	0	This bit when set to one selects the base address A22 for post write range 1.
5	R/W	0	This bit when set to one selects the base address A21 for post write range 1.
4	R/W	0	This bit when set to one selects the base address A20 for post write range 1.
3	R/W	0	This bit when set to one selects the base address A19 for post write range 1.
2	R/W	0	This bit when set to one selects the base address A18 for post write range 1.
1	R/W	0	This bit when set to one selects the base address A17 for post write range 1.
0	R/W	0	This bit when set to one selects the base address A16 for post write range 1.

Register 4Fh

Bit	R/W	Default	Function
7	R/W	0	This bit when set to one selects the base address A31 for post write range 1.
6	R/W	0	This bit when set to one selects the base address A30 for post write range 1.
5	R/W	0	This bit when set to one selects the base address A29 for post write range 1.
4	R/W	0	This bit when set to one selects the base address A28 for post write range 1.
3	R/W	0	This bit when set to one selects the base address A27 for post write range 1.
2	R/W	0	This bit when set to one selects the base address A26 for post write range 1.
1	R/W	0	This bit when set to one selects the base address A25 for post write range 1.
0	R/W	0	This bit when set to one selects the base address A24 for post write range 1.

PCI Post Write Range 0 Selection Register 50h

Bit	R/W	Default	Function																																																															
7	R/W	0	When set to one segments A000h and B000h will be selected as post write range 0.																																																															
6-5	R	0	Reserved. A zero will be returned when these bits are read.																																																															
4-0	R/W	00000	<p>Post write size for range 0.</p> <table border="1"> <thead> <tr> <th>Bits</th> <th>Address Range</th> <th>Post Write Size</th> </tr> </thead> <tbody> <tr> <td>43210</td> <td></td> <td></td> </tr> <tr> <td>00000</td> <td>don't care</td> <td>Post writeable range disabled (default).</td> </tr> <tr> <td>00001</td> <td>A16-A31</td> <td>64K</td> </tr> <tr> <td>00010</td> <td>A17-A31</td> <td>128K</td> </tr> <tr> <td>00011</td> <td>A18-A31</td> <td>256K</td> </tr> <tr> <td>00100</td> <td>A19-A31</td> <td>512K</td> </tr> <tr> <td>00101</td> <td>A20-A31</td> <td>1M</td> </tr> <tr> <td>00110</td> <td>A21-A31</td> <td>2M</td> </tr> <tr> <td>00111</td> <td>A22-A31</td> <td>4M</td> </tr> <tr> <td>01000</td> <td>A23-A31</td> <td>8M</td> </tr> <tr> <td>01001</td> <td>A24-A31</td> <td>16M</td> </tr> <tr> <td>01010</td> <td>A25-A31</td> <td>32M</td> </tr> <tr> <td>01011</td> <td>A26-A31</td> <td>64M</td> </tr> <tr> <td>01100</td> <td>A27-A31</td> <td>128M</td> </tr> <tr> <td>01101</td> <td>A28-A31</td> <td>256M</td> </tr> <tr> <td>01110</td> <td>A29-A31</td> <td>512M</td> </tr> <tr> <td>01111</td> <td>A30-A31</td> <td>1G</td> </tr> <tr> <td>10000</td> <td>A31</td> <td>2G</td> </tr> <tr> <td>10001</td> <td></td> <td>All range post writeable</td> </tr> <tr> <td>others</td> <td></td> <td>Undefined</td> </tr> </tbody> </table>	Bits	Address Range	Post Write Size	43210			00000	don't care	Post writeable range disabled (default).	00001	A16-A31	64K	00010	A17-A31	128K	00011	A18-A31	256K	00100	A19-A31	512K	00101	A20-A31	1M	00110	A21-A31	2M	00111	A22-A31	4M	01000	A23-A31	8M	01001	A24-A31	16M	01010	A25-A31	32M	01011	A26-A31	64M	01100	A27-A31	128M	01101	A28-A31	256M	01110	A29-A31	512M	01111	A30-A31	1G	10000	A31	2G	10001		All range post writeable	others		Undefined
Bits	Address Range	Post Write Size																																																																
43210																																																																		
00000	don't care	Post writeable range disabled (default).																																																																
00001	A16-A31	64K																																																																
00010	A17-A31	128K																																																																
00011	A18-A31	256K																																																																
00100	A19-A31	512K																																																																
00101	A20-A31	1M																																																																
00110	A21-A31	2M																																																																
00111	A22-A31	4M																																																																
01000	A23-A31	8M																																																																
01001	A24-A31	16M																																																																
01010	A25-A31	32M																																																																
01011	A26-A31	64M																																																																
01100	A27-A31	128M																																																																
01101	A28-A31	256M																																																																
01110	A29-A31	512M																																																																
01111	A30-A31	1G																																																																
10000	A31	2G																																																																
10001		All range post writeable																																																																
others		Undefined																																																																

PCI Post Write Range 1 Selection Register 51h

Bit	R/W	Default	Function																																																															
7-5	R	0	Reserved. A zero will be returned when these bits are read.																																																															
4-0	R/W	00000	<p>Post write size for range 1.</p> <table border="1"> <thead> <tr> <th>Bits</th> <th>Address Compared</th> <th>Post Write Size</th> </tr> </thead> <tbody> <tr> <td>43210</td> <td></td> <td></td> </tr> <tr> <td>00000</td> <td>don't care</td> <td>Post writeable range disabled (default).</td> </tr> <tr> <td>00001</td> <td>A16-A31</td> <td>64K</td> </tr> <tr> <td>00010</td> <td>A17-A31</td> <td>128K</td> </tr> <tr> <td>00011</td> <td>A18-A31</td> <td>256K</td> </tr> <tr> <td>00100</td> <td>A19-A31</td> <td>512K</td> </tr> <tr> <td>00101</td> <td>A20-A31</td> <td>1M</td> </tr> <tr> <td>00110</td> <td>A21-A31</td> <td>2M</td> </tr> <tr> <td>00111</td> <td>A22-A31</td> <td>4M</td> </tr> <tr> <td>01000</td> <td>A23-A31</td> <td>8M</td> </tr> <tr> <td>01001</td> <td>A24-A31</td> <td>16M</td> </tr> <tr> <td>01010</td> <td>A25-A31</td> <td>32M</td> </tr> <tr> <td>01011</td> <td>A26-A31</td> <td>64M</td> </tr> <tr> <td>01100</td> <td>A27-A31</td> <td>128M</td> </tr> <tr> <td>01101</td> <td>A28-A31</td> <td>256M</td> </tr> <tr> <td>01110</td> <td>A29-A31</td> <td>512M</td> </tr> <tr> <td>01111</td> <td>A30-A31</td> <td>1G</td> </tr> <tr> <td>10000</td> <td>A31</td> <td>2G</td> </tr> <tr> <td>10001</td> <td></td> <td>All range post writeable</td> </tr> <tr> <td>others</td> <td></td> <td>Undefined</td> </tr> </tbody> </table>	Bits	Address Compared	Post Write Size	43210			00000	don't care	Post writeable range disabled (default).	00001	A16-A31	64K	00010	A17-A31	128K	00011	A18-A31	256K	00100	A19-A31	512K	00101	A20-A31	1M	00110	A21-A31	2M	00111	A22-A31	4M	01000	A23-A31	8M	01001	A24-A31	16M	01010	A25-A31	32M	01011	A26-A31	64M	01100	A27-A31	128M	01101	A28-A31	256M	01110	A29-A31	512M	01111	A30-A31	1G	10000	A31	2G	10001		All range post writeable	others		Undefined
Bits	Address Compared	Post Write Size																																																																
43210																																																																		
00000	don't care	Post writeable range disabled (default).																																																																
00001	A16-A31	64K																																																																
00010	A17-A31	128K																																																																
00011	A18-A31	256K																																																																
00100	A19-A31	512K																																																																
00101	A20-A31	1M																																																																
00110	A21-A31	2M																																																																
00111	A22-A31	4M																																																																
01000	A23-A31	8M																																																																
01001	A24-A31	16M																																																																
01010	A25-A31	32M																																																																
01011	A26-A31	64M																																																																
01100	A27-A31	128M																																																																
01101	A28-A31	256M																																																																
01110	A29-A31	512M																																																																
01111	A30-A31	1G																																																																
10000	A31	2G																																																																
10001		All range post writeable																																																																
others		Undefined																																																																

4.1.2 IDE Burstable Address 1 (Registers 52h, 53h)

Register 52h

Bit	R/W	Default	Function
7	R/W	0	This bit when set to one selects base address A7 for IDE burstable address 1.
6	R/W	0	This bit when set to one selects base address A6 for IDE burstable address 1.
5	R/W	0	This bit when set to one selects base address A5 for IDE burstable address 1.
4	R/W	0	This bit when set to one selects base address A4 for IDE burstable address 1.
3	R/W	0	This bit when set to one selects base address A3 for IDE burstable address 1.
2-1	R	0	Reserved. A zero will be returned when these bits are read.
0	R/W	0	When set to one the primary IDE burstable address 1 is enabled.

Register 53h

Bit	R/W	Default	Function
7	R/W	0	This bit when set to one selects base address A15 for IDE burstable address 1.
6	R/W	0	This bit when set to one selects base address A14 for IDE burstable address 1.
5	R/W	0	This bit when set to one selects base address A13 for IDE burstable address 1.
4	R/W	0	This bit when set to one selects base address A12 for IDE burstable address 1.
3	R/W	0	This bit when set to one selects base address A11 for IDE burstable address 1.
2	R/W	0	This bit when set to one selects base address A10 for IDE burstable address 1.
1	R/W	0	This bit when set to one selects base address A9 for IDE burstable address 1.
0	R/W	0	This bit when set to one selects base address A8 for IDE burstable address 1.

IDE Burstable Address 2 (Registers 54h, 55h)**Register 54h**

Bit	R/W	Default	Function
7	R/W	0	This bit when set to one selects base address A7 for IDE burstable address 2.
6	R/W	0	This bit when set to one selects base address A6 for IDE burstable address 2.
5	R/W	0	This bit when set to one selects base address A5 for IDE burstable address 2.
4	R/W	0	This bit when set to one selects base address A4 for IDE burstable address 2.
3	R/W	0	This bit when set to one selects base address A3 for IDE burstable address 2.
2-1	R	0	Reserved. A zero will be returned when these bits are read.
0	R/W	0	When set to one the IDE burstable address 2 is enabled.

Register 55h

Bit	R/W	Default	Function
7	R/W	0	This bit when set to one selects base address A15 for IDE burstable address 2.
6	R/W	0	This bit when set to one selects base address A14 for IDE burstable address 2.
5	R/W	0	This bit when set to one selects base address A13 for IDE burstable address 2.
4	R/W	0	This bit when set to one selects base address A12 for IDE burstable address 2.
3	R/W	0	This bit when set to one selects base address A11 for IDE burstable address 2.
2	R/W	0	This bit when set to one selects base address A10 for IDE burstable address 2.
1	R/W	0	This bit when set to one selects base address A9 for IDE burstable address 2.
0	R/W	0	This bit when set to one selects base address A8 for IDE burstable address 2.

PCI Clock Mode Register 56h

Bit	R/W	Default	Function
7-2	R	0	Reserved.
1-0	R/W	0	PCI clock mode select. Bits PCI Clock Mode 10 00 Asynchronous mode (default mode) 10 Synchronous mode 11 Synchronized CPU clock = 2x PCI clock

PCI Feature Control Register 57h

Bit	R/W	Default	Function
7-6	R	0	Reserved.
5	R/W	0	When set to one the PCI cycle will be retried when the write FIFO is busy.
4	R/W	0	When set to one /DEVSEL is asserted immediately after /FRAME is sampled without a wait state.
3	R	0	Reserved.
2	R/W	0	When set to zero PCI to memory accesses are disconnected at the end of each cache line.
1	R/W	0	When set to one L1 snoop is performed for the next cache line while the current line is being accessed.
0	R/W	0	When set to one L1 snoop hit write backs during PCI to memory reads pass data through to PCI bus. When set to zero data is written back to memory then read from memory.

4.2 Memory Configuration**DRAM Options Control Register 5Eh**

Bit	R/W	Default	Function
7	R	0	Reserved.
6	R/W	0	When set to one the linear burst mode will be enabled to support the Cyrix M1 CPU.
5	R/W	0	When set to one the DRAM posted write buffer will be enabled.
4	R/W	0	When set to one the fast pipeline mode will be enabled.
3	R/W	0	When set to one DRAM read will be complete before write is posted in the buffers.
2	R/W	0	When set to one the L2 write back cache to posted write back buffer will be enabled.
1	R/W	0	When set to one the PCI to DRAM data flow will be delayed by one wait state.
0	R/W	0	When set to one a NA signal will be generated during CPU access memory and this access is burstabled.

4.2.1 DRAM Size (Registers 5Fh-63h)

The ACC Micro 2051nt supports 5 rows of DRAM. Each row is either 32 bits or 64 bits wide. The DRAM Size Registers define the lower addresses for each row.

Configuration Register 5Fh, Row 0

Configuration Register 60h, Row 1

Configuration Register 61h, Row 2

Configuration Register 62h, Row 3

Configuration Register 63h, Row 4

Bit	R/W	Default	Function
7	R/W	0	This bit when set to one selects the base address A28 for DRAM size for the appropriate bank, as specified above.
6	R/W	0	This bit selects the base address A27 for DRAM size.
5	R/W	0	This bit selects the base address A26 for DRAM size.
4	R/W	0	This bit selects the base address A25 for DRAM size.
3	R/W	0	This bit selects the base address A24 for DRAM size.
2	R/W	0	This bit selects the base address A23 for DRAM size.
1	R/W	0	This bit selects the base address A22 for DRAM size.
0	R/W	0	This bit selects the base address A21 for DRAM size.

DRAM Type (Registers 64h-67h)

These registers identify the types of DRAM (EDO or fast page mode; 32bit or 64bit (as default); symmetric or asymmetric) used in each ROW. The system BIOS should be programmed accordingly.

Register 64h

Bit	R/W	Default	Function
7-5	R	0	Reserved.
4	R/W	1	When set to one bank 4 is configured for EDO DRAM. For Fast Page mode DRAM, set this bit to zero.
3	R/W	1	When set to one bank 3 is configured for EDO DRAM. For Fast Page mode DRAM, set this bit to zero.
2	R/W	1	When set to one bank 2 is configured for EDO DRAM. For Fast Page mode DRAM, set this bit to zero.
1	R/W	1	When set to one bank 1 is configured for EDO DRAM. For Fast Page mode DRAM, set this bit to zero.
0	R/W	1	When set to one bank 0 is configured for EDO DRAM. For Fast Page mode DRAM, set this bit to zero.

Register 65h

Bit	R/W	Default	Function
7-5	R	0	Reserved.
4	R/W	0	When set to one bank 4 is configured for 32-bit DRAM.
3	R/W	0	When set to one bank 3 is configured for 32-bit DRAM.
2	R/W	0	When set to one bank 2 is configured for 32-bit DRAM.
1	R/W	0	When set to one bank 1 is configured for 32-bit DRAM.
0	R/W	0	When set to one bank 0 is configured for 32-bit DRAM.

Register 66h

Bit	R/W	Default	Function
7-5	R	0	Reserved.
4	R/W	0	When set to one, bank 4 is configured for 12x12 symmetric DRAM.
3	R/W	0	When set to one, bank 3 is configured for 12x12 symmetric DRAM.
2	R/W	0	When set to one, bank 2 is configured for 12x12 symmetric DRAM.
1	R/W	0	When set to one, bank 1 is configured for 12x12 symmetric DRAM.
0	R/W	0	When set to one, bank 0 is configured for 12x12 symmetric DRAM.

Register 67h

Bit	R/W	Default	Function
7-5	R	0	Reserved.
4	R/W	0	When set to one bank 4 is configured for 12x9 asymmetric DRAM.
3	R/W	0	When set to one bank 3 is configured for 12x9 asymmetric DRAM.
2	R/W	0	When set to one bank 2 is configured for 12x9 asymmetric DRAM.
1	R/W	0	When set to one bank 1 is configured for 12x9 asymmetric DRAM.
0	R/W	0	When set to one bank 0 is configured for 12x9 asymmetric DRAM.

DRAM Timing (Registers 68h and 6Bh)

These registers provide configuration of RAS and CAS characteristics.

Register 68h

Bit	R/W	Default	Function																				
7-6	R/W	1	Burst refresh precharge cycle width. <table> <thead> <tr> <th>Bits</th> <th>Cycle Width</th> </tr> </thead> <tbody> <tr> <td>76</td> <td></td> </tr> <tr> <td>00</td> <td>1T</td> </tr> <tr> <td>01</td> <td>2T</td> </tr> <tr> <td>10</td> <td>3T</td> </tr> <tr> <td>11</td> <td>4T</td> </tr> </tbody> </table>	Bits	Cycle Width	76		00	1T	01	2T	10	3T	11	4T								
Bits	Cycle Width																						
76																							
00	1T																						
01	2T																						
10	3T																						
11	4T																						
5-4	R/W	1	Burst refresh active cycle width. <table> <thead> <tr> <th>Bits</th> <th>Cycle Width</th> </tr> </thead> <tbody> <tr> <td>54</td> <td></td> </tr> <tr> <td>00</td> <td>1T</td> </tr> <tr> <td>01</td> <td>2T</td> </tr> <tr> <td>10</td> <td>3T</td> </tr> <tr> <td>11</td> <td>4T</td> </tr> </tbody> </table>	Bits	Cycle Width	54		00	1T	01	2T	10	3T	11	4T								
Bits	Cycle Width																						
54																							
00	1T																						
01	2T																						
10	3T																						
11	4T																						
3	R/W	1	When set to one burst refresh will be enabled.																				
2-0	R/W	0	Burst refresh count select. <table> <thead> <tr> <th>Bits</th> <th>Burst Number</th> </tr> </thead> <tbody> <tr> <td>210</td> <td></td> </tr> <tr> <td>000</td> <td>1</td> </tr> <tr> <td>001</td> <td>2</td> </tr> <tr> <td>010</td> <td>3</td> </tr> <tr> <td>011</td> <td>4</td> </tr> <tr> <td>100</td> <td>5</td> </tr> <tr> <td>101</td> <td>6</td> </tr> <tr> <td>110</td> <td>7</td> </tr> <tr> <td>111</td> <td>8</td> </tr> </tbody> </table>	Bits	Burst Number	210		000	1	001	2	010	3	011	4	100	5	101	6	110	7	111	8
Bits	Burst Number																						
210																							
000	1																						
001	2																						
010	3																						
011	4																						
100	5																						
101	6																						
110	7																						
111	8																						

Register 69h

Bit	R/W	Default	Function
7-6	R/W	1	RAS precharge select for Fast Page mode and EDO memory. Bits RAS Precharge 76 00 2T 01 3T 10 4T 11 5T
5	R/W	1	When set to one the RAS to CAS delay time is 3 cycles for read. When set to zero, the RAS to CAS delay is 2 cycles.
4	R/W	1	When set to one the RAS to CAS delay time is 3 cycles for write. When set to zero, the RAS to CAS delay is 2 cycles.
3-2	R/W	1	CAS precharge select for read cycle for fast page mode DRAM. Bits CAS Precharge 32 00 1T 01 2T 10 3T 11 4T
1-0	R/W	1	CAS width select for read cycle for fast page mode DRAM. Bits CAS Width 10 00 1T 01 2T 10 3T 11 4T

Register 6Ah

Bit	R/W	Default	Function
7	R	0	Reserved.
6	R/W	0	Set to one to enable long CAS precharge for EDO detection.
5	R/W	0	When set to one CAS will be activated 1/2 cycle earlier for read cycle.
4	R/W	0	When set to one CAS will be activated 1/2 cycle earlier for write cycle.
3	R/W	1	When set to one CAS precharge will be set to 2T in write back cycle. It equals 1T when set to zero.
2	R/W	1	When set to one the CAS precharge for write cycle is 2T. The CAS precharge is 1T when set to zero for fast page mode DRAM.
1-0	R/W	1	CAS width select for write cycle. Bits CAS Width for Write 10 00 1T 01 2T 10 3T 11 4T

Register 6Bh

Bit	R/W	Default	Function
7-6	R/W	1	EDO DRAM CAS precharge for read cycle. Bits CAS Precharge 76 00 1T 01 2T 10 3T 11 4T
5-4	R/W	1	EDO DRAM CAS width for read cycle. Bits CAS Width 54 00 1T 01 2T 10 3T 11 4T
3	R	0	Reserved.
2	R/W	1	This bit selects the EDO DRAM CAS precharge for write cycle. When set to one it equals 2T. It equals 1T when set to zero.
1-0	R/W	1	EDO DRAM CAS width for write cycle. Bits CAS Width 10 00 1T 01 2T 10 3T 11 4T

Shadow Control (Registers 6Ch - 6Fh)

Register 6Ch

Bit	R/W	Default	Function
7	R/W	0	When set to one the shadow write segment CC000-CFFFF is enabled .
6	R/W	0	When set to one the shadow read segment CC000-CFFFF is enabled.
5	R/W	0	When set to one the shadow write segment C8000-CBFFF is enabled.
4	R/W	0	When set to one the shadow read segment C8000-CBFFF is enabled.
3	R/W	0	When set to one the shadow write segment C4000-C7FFF is enabled.
2	R/W	0	When set to one the shadow read segment C4000-C7FFF is enabled.
1	R/W	0	When set to one the shadow write segment C0000-C3FFF is enabled.
0	R/W	0	When set to one the shadow read segment C0000-C3FFF is enabled.

Register 6Dh

Bit	R/W	Default	Function
7	R/W	0	When set to one the shadow write segment DC000-DFFFF is enabled .
6	R/W	0	When set to one the shadow read segment DC000-DFFFF is enabled.
5	R/W	0	When set to one the shadow write segment D8000-DBFFF is enabled.
4	R/W	0	When set to one the shadow read segment D8000-DBFFF is enabled.
3	R/W	0	When set to one the shadow write segment D4000-D7FFF is enabled.
2	R/W	0	When set to one the shadow read segment D4000-D7FFF is enabled.
1	R/W	0	When set to one the shadow write segment D0000-D3FFF is enabled.
0	R/W	0	When set to one the shadow read segment D0000-D3FFF is enabled.

Register 6Eh

Bit	R/W	Default	Function
7	R/W	0	When set to one the shadow write segment EC000-EFFFF is enabled .
6	R/W	0	When set to one the shadow read segment EC000-EFFFF is enabled.
5	R/W	0	When set to one the shadow write segment E8000-EBFFF is enabled.
4	R/W	0	When set to one the shadow read segment E8000-EBFFF is enabled.
3	R/W	0	When set to one the shadow write segment E4000-E7FFF is enabled.
2	R/W	0	When set to one the shadow read segment E4000-E7FFF is enabled.
1	R/W	0	When set to one the shadow read segment E0000-E3FFF is enabled.
0	R/W	0	When set to one the shadow read segment E0000-E3FFF is enabled.

Register 6Fh

Bit	R/W	Default	Function
7	R/W	0	When set to one the shadow write segment FC000-FFFFFF is enabled .
6	R/W	0	When set to one the shadow read segment FC000-FFFFFF is enabled.
5	R/W	0	When set to one the shadow write segment F8000-FBFFF is enabled.
4	R/W	0	When set to one the shadow read segment F8000-FBFFF is enabled.
3	R/W	0	When set to one the shadow write segment F4000-F7FFF is enabled.
2	R/W	0	When set to one the shadow read segment F4000-F7FFF is enabled.
1	R/W	0	When set to one the shadow write segment F0000-F3FFF is enabled.
0	R/W	0	When set to one the shadow read segment F0000-F3FFF is enabled.

DRAM Bank Relocation (Registers 70h-72h)

Register 70h

Bit	R/W	Default	Function
7	R	0	Reserved.
6	R/W	0	DRAM bank relocation bit 2 for bank 1.
5	R/W	0	DRAM bank relocation bit 1 for bank 1.
4	R/W	1	DRAM bank relocation bit 0 for bank 1.
3	R	0	Reserved.
2	R/W	0	DRAM bank relocation bit 2 for bank 0.
1	R/W	0	DRAM bank relocation bit 1 for bank 0.
0	R/W	0	DRAM bank relocation bit 0 for bank 0.

Example: By default, DRAM's banks are not relocated, i.e., bank 0 stays at bank 0, bank 1 stays at bank 1, etc. To relocate bank 1 to bank 2, set Register 70h, bit 6-4 to 010.

Register 71h

Bit	R/W	Default	Function
7	R	0	Reserved.
6-4	R/W	011	These bits select the DRAM bank relocation for bank 3.
3	R	0	Reserved.
2-0	R/W	010	These bits select the DRAM bank relocation for bank 2.

Register 72h

Bit	R/W	Default	Function
7	R/W	0	When set to one the segment 80000 and segment 90000 are readable.
6	R/W	0	When set to one the segment 80000 and segment 90000 are writeable.
5	R/W	0	When set to one the segment 80000 and segment 90000 are cacheable. Segment 80000h and 90000h should always be set to cacheable.
4	R/W	0	When set to one the remap function will be enabled.
3	R/W	0	When set to one the MA latch will be asserted 1/2 clock earlier to support earlier /CAS.
2-0	R/W	100	These bits select the DRAM bank relocation for bank 4.

SMM Setup Register 73h

Bit	R/W	Default	Function
7-4	R	0	Reserved. A zero will be returned when these bits are read.
3	R/W	0	Set to one to initialize the SMM space.
2	R/W	0	When set to one SMM space will be set to segment 30000h.
1	R/W	0	When set to one SMM space will be set to segment A0000h.
0	R/W	0	When set to one SMM space will be set to segment B0000h.

4.2.2 L2 Cache

The ACC Micro 2051nt can control asynchronous, burst, and pipeline burst SRAM. Register 74h-76h select and configure the application for L2 cache.

L2 Cache Type Register 74h

Bit	R/W	Default	Function
7-4	R	0	Reserved.
3	R/W	0	When set to one this bit enables TAG7.
2	R/W	0	When set to one Asynchronous SRAM for L2 cache is selected.
1	R/W	0	When set to one non-pipe Burst SRAM for L2 cache is selected.
0	R/W	0	When set to one Pipeline burst SRAM for L2 cache is selected.

L2 Cache Initialization Register 75h

Bit	R/W	Default	Function																				
7	R/W	0	When set to one external tag will be ignored																				
6	R/W	0	When set to one cache will be set to always hit for cache initialization. When set to zero, cache will be set to always miss.																				
5	R/W	0	When set to one the data in L2 cache will be forced to a non-dirty state.																				
4	R/W	0	This bit selects the advanced cache clock (KCLK) for writes to cache (3ns-8ns faster).																				
3	R/W	0	When set to one L2 write-back implementation is selected. When set to zero, L2 write-through is selected.																				
2-0	R/W	0	L2 cache size select. <table border="0"> <thead> <tr> <th>Bits</th> <th>Cache Size</th> </tr> </thead> <tbody> <tr> <td>210</td> <td></td> </tr> <tr> <td>000</td> <td>64K</td> </tr> <tr> <td>001</td> <td>128K</td> </tr> <tr> <td>010</td> <td>256K</td> </tr> <tr> <td>011</td> <td>512K</td> </tr> <tr> <td>100</td> <td>1K</td> </tr> <tr> <td>101</td> <td>2M</td> </tr> <tr> <td>110</td> <td>Undefined</td> </tr> <tr> <td>111</td> <td>Undefined</td> </tr> </tbody> </table>	Bits	Cache Size	210		000	64K	001	128K	010	256K	011	512K	100	1K	101	2M	110	Undefined	111	Undefined
Bits	Cache Size																						
210																							
000	64K																						
001	128K																						
010	256K																						
011	512K																						
100	1K																						
101	2M																						
110	Undefined																						
111	Undefined																						

Burst Timing and L2 Cache Timing Register 76h (for asynchronous L2 cache)

Bit	R/W	Default	Function												
7-6	R	0	Reserved.												
5	R/W	0	When set to one, cache burst for read cycle is x-2-2-2. When set to zero, x-3-3-3 cache burst for read is selected.												
4	R/W	0	When set to one, cache burst for write cycle is x-2-2-2. When set to zero, x-3-3-3 cache burst for write is selected.												
3-2	R/W	11	Wait state select for burst read lead-off cycle. <table border="0"> <thead> <tr> <th>Bits</th> <th>Lead-Off Cycle</th> </tr> </thead> <tbody> <tr> <td>32</td> <td></td> </tr> <tr> <td>00</td> <td>Reserved.</td> </tr> <tr> <td>01</td> <td>3-x-x-x</td> </tr> <tr> <td>10</td> <td>4-x-x-x</td> </tr> <tr> <td>11</td> <td>4-x-x-x</td> </tr> </tbody> </table>	Bits	Lead-Off Cycle	32		00	Reserved.	01	3-x-x-x	10	4-x-x-x	11	4-x-x-x
Bits	Lead-Off Cycle														
32															
00	Reserved.														
01	3-x-x-x														
10	4-x-x-x														
11	4-x-x-x														
1-0	R/W	11	Wait state select for burst write lead-off cycle. <table border="0"> <thead> <tr> <th>Bits</th> <th>Lead-Off Cycle</th> </tr> </thead> <tbody> <tr> <td>10</td> <td></td> </tr> <tr> <td>00</td> <td>Reserved.</td> </tr> <tr> <td>01</td> <td>3-x-x-x</td> </tr> <tr> <td>10</td> <td>4-x-x-x</td> </tr> <tr> <td>11</td> <td>4-x-x-x</td> </tr> </tbody> </table>	Bits	Lead-Off Cycle	10		00	Reserved.	01	3-x-x-x	10	4-x-x-x	11	4-x-x-x
Bits	Lead-Off Cycle														
10															
00	Reserved.														
01	3-x-x-x														
10	4-x-x-x														
11	4-x-x-x														

Shadow Cache Control (Registers 77h-78h)**Register 77h**

Bit	R/W	Default	Function
7	R/W	0	When set to one the shadow segment DC000-DFFFF is cacheable.
6	R/W	0	When set to one the shadow segment D8000-DBFFF is cacheable.
5	R/W	0	When set to one the shadow segment D4000-D7FFF is cacheable.
4	R/W	0	When set to one the shadow segment D0000-D3FFF is cacheable.
3	R/W	0	When set to one the shadow segment CC000-CFFFF is cacheable.
2	R/W	0	When set to one the shadow segment C8000-CBFFF is cacheable.
1	R/W	0	When set to one the shadow segment C4000-C7FFF is cacheable.
0	R/W	0	When set to one the shadow segment C0000-C3FFF is cacheable.

Register 78h

Bit	R/W	Default	Function
7	R/W	0	When set to one the shadow segment FC000-FFFFFF is cacheable.
6	R/W	0	When set to one the shadow segment F8000-FBFFF is cacheable.
5	R/W	0	When set to one the shadow segment F4000-F7FFF is cacheable.
4	R/W	0	When set to one the shadow segment F0000-F3FFF is cacheable.
3	R/W	0	When set to one the shadow segment EC000-EFFFF is cacheable.
2	R/W	0	When set to one the shadow segment E8000-EBFFF is cacheable.
1	R/W	0	When set to one the shadow segment E4000-E7FFF is cacheable.
0	R/W	0	When set to one the shadow segment E0000-E3FFF is cacheable.

Non-cacheable Range (Registers 79h-7Ch)

These registers select the lower address for the non-cacheable range and the range size.

Non-cacheable Range 0 Size Register 79h

Bit	R/W	Default	Function																																																
7	R/W	0	This bit selects the starting base address A19 for non-cacheable range 0.																																																
6	R/W	0	This bit selects the starting base address A18 for non-cacheable range 0.																																																
5	R/W	0	This bit selects the starting base address A17 for non-cacheable range 0.																																																
4	R/W	0	This bit selects the starting base address A16 for non-cacheable range 0.																																																
3-0	R/W	0	<p>Sets non-cacheable range 0 size as follows:</p> <table border="1"> <thead> <tr> <th>Bits</th> <th>Addr. Compared</th> <th>Non-cacheable Range Size</th> </tr> </thead> <tbody> <tr> <td>3210</td> <td></td> <td></td> </tr> <tr> <td>0000</td> <td>don't care</td> <td>all cacheable (default)</td> </tr> <tr> <td>0001</td> <td>16-27</td> <td>64K</td> </tr> <tr> <td>0010</td> <td>17-27</td> <td>128K</td> </tr> <tr> <td>0011</td> <td>18-27</td> <td>256K</td> </tr> <tr> <td>0100</td> <td>19-27</td> <td>512K</td> </tr> <tr> <td>0101</td> <td>20-27</td> <td>1M</td> </tr> <tr> <td>0110</td> <td>21-27</td> <td>2M</td> </tr> <tr> <td>0111</td> <td>22-27</td> <td>4M</td> </tr> <tr> <td>1000</td> <td>23-27</td> <td>8M</td> </tr> <tr> <td>1001</td> <td>24-27</td> <td>16M</td> </tr> <tr> <td>1010</td> <td>25-27</td> <td>32M</td> </tr> <tr> <td>1011</td> <td>26-27</td> <td>64M</td> </tr> <tr> <td>1100</td> <td>27</td> <td>128M</td> </tr> <tr> <td>1101-1111</td> <td></td> <td>Undefined</td> </tr> </tbody> </table> <p>Example: If the non-cacheable range size is set to 1M, A20-A27 will be used as the comparison addresses. And if the non-cacheable range starts at 16MB boundary, then base address A24 needs to be set to one. Any base address below A20 will be treated as 0's.</p>	Bits	Addr. Compared	Non-cacheable Range Size	3210			0000	don't care	all cacheable (default)	0001	16-27	64K	0010	17-27	128K	0011	18-27	256K	0100	19-27	512K	0101	20-27	1M	0110	21-27	2M	0111	22-27	4M	1000	23-27	8M	1001	24-27	16M	1010	25-27	32M	1011	26-27	64M	1100	27	128M	1101-1111		Undefined
Bits	Addr. Compared	Non-cacheable Range Size																																																	
3210																																																			
0000	don't care	all cacheable (default)																																																	
0001	16-27	64K																																																	
0010	17-27	128K																																																	
0011	18-27	256K																																																	
0100	19-27	512K																																																	
0101	20-27	1M																																																	
0110	21-27	2M																																																	
0111	22-27	4M																																																	
1000	23-27	8M																																																	
1001	24-27	16M																																																	
1010	25-27	32M																																																	
1011	26-27	64M																																																	
1100	27	128M																																																	
1101-1111		Undefined																																																	

Non-cacheable Range 0 Address Register 7Ah

Bit	R/W	Default	Function
7	R/W	0	This bit selects the starting base address A27 for non-cacheable range 0.
6	R/W	0	This bit selects the starting base address A26 for non-cacheable range 0.
5	R/W	0	This bit selects the starting base address A25 for non-cacheable range 0.
4	R/W	0	This bit selects the starting base address A24 for non-cacheable range 0.
3	R/W	0	This bit selects the starting base address A23 for non-cacheable range 0.
2	R/W	0	This bit selects the starting base address A22 for non-cacheable range 0.
1	R/W	0	This bit selects the starting base address A21 for non-cacheable range 0.
0	R/W	0	This bit selects the starting base address A20 for non-cacheable range 0.

Non-cacheable Range

Non-cacheable Range 1 Size Register 7Bh

Bit	R/W	Default	Function																																																
7	R/W	0	This bit selects the starting base address A19 for non-cacheable range 1.																																																
6	R/W	0	This bit selects the starting base address A18 for non-cacheable range 1.																																																
5	R/W	0	This bit selects the starting base address A17 for non-cacheable range 1.																																																
4	R/W	0	This bit selects the starting base address A16 for non-cacheable range 1.																																																
3-0	R/W	0	<p>Sets non-cacheable range 1 size as follows:</p> <table border="1"> <thead> <tr> <th>Bits</th> <th>Addr. Compared</th> <th>Non-cacheable Range Size</th> </tr> </thead> <tbody> <tr> <td>3210</td> <td></td> <td></td> </tr> <tr> <td>0000</td> <td>don't care</td> <td>all cacheable (default)</td> </tr> <tr> <td>0001</td> <td>16-27</td> <td>64K</td> </tr> <tr> <td>0010</td> <td>17-27</td> <td>128K</td> </tr> <tr> <td>0011</td> <td>18-27</td> <td>256K</td> </tr> <tr> <td>0100</td> <td>19-27</td> <td>512K</td> </tr> <tr> <td>0101</td> <td>20-27</td> <td>1M</td> </tr> <tr> <td>0110</td> <td>21-27</td> <td>2M</td> </tr> <tr> <td>0111</td> <td>22-27</td> <td>4M</td> </tr> <tr> <td>1000</td> <td>23-27</td> <td>8M</td> </tr> <tr> <td>1001</td> <td>24-27</td> <td>16M</td> </tr> <tr> <td>1010</td> <td>25-27</td> <td>32M</td> </tr> <tr> <td>1011</td> <td>26-27</td> <td>64M</td> </tr> <tr> <td>1100</td> <td>27</td> <td>128M</td> </tr> <tr> <td>1101-1111</td> <td></td> <td>Undefined</td> </tr> </tbody> </table> <p>Example: If the non-cacheable range size is set to 1M, A20-A27 will be used as the comparison addresses. And if the non-cacheable range starts at 16MB boundary, then base address A24 needs to be set to one. Any base address below A20 will be treated as 0's.</p>	Bits	Addr. Compared	Non-cacheable Range Size	3210			0000	don't care	all cacheable (default)	0001	16-27	64K	0010	17-27	128K	0011	18-27	256K	0100	19-27	512K	0101	20-27	1M	0110	21-27	2M	0111	22-27	4M	1000	23-27	8M	1001	24-27	16M	1010	25-27	32M	1011	26-27	64M	1100	27	128M	1101-1111		Undefined
Bits	Addr. Compared	Non-cacheable Range Size																																																	
3210																																																			
0000	don't care	all cacheable (default)																																																	
0001	16-27	64K																																																	
0010	17-27	128K																																																	
0011	18-27	256K																																																	
0100	19-27	512K																																																	
0101	20-27	1M																																																	
0110	21-27	2M																																																	
0111	22-27	4M																																																	
1000	23-27	8M																																																	
1001	24-27	16M																																																	
1010	25-27	32M																																																	
1011	26-27	64M																																																	
1100	27	128M																																																	
1101-1111		Undefined																																																	

Non-cacheable Range 1 Address Register 7Ch

Bit	R/W	Default	Function
7	R/W	0	This bit selects the starting base address A27 for non-cacheable range 1.
6	R/W	0	This bit selects the starting base address A26 for non-cacheable range 1.
5	R/W	0	This bit selects the starting base address A25 for non-cacheable range 1.
4	R/W	0	This bit selects the starting base address A24 for non-cacheable range 1.
3	R/W	0	This bit selects the starting base address A23 for non-cacheable range 1.
2	R/W	0	This bit selects the starting base address A22 for non-cacheable range 1.
1	R/W	0	This bit selects the starting base address A21 for non-cacheable range 1.
0	R/W	0	This bit selects the starting base address A20 for non-cacheable range 1.

4.3 Power Mangement

The ACC Micro Power Management offers four operation modes: Fully-on, Suspend, Doze, and Standby. Registers 80h, 81h, 82h, 83h, 84h, 85h, 86h, 87h, 88h, 89h, and 8Ah provide configuration options to optimize the power management features for notebook applications.

4.3.1 Suspend Control (Registers 80h, 81h)

When the system enters the suspend mode, i.e, the auto suspend timer times-out (reg. 43h refer to page 99) or the /SRBTN is asserted, the CPU, PCI, and ISA interfaces will be driven low so that their devices can be powered-off by programming registers 80h and 81h.

Register 80h

Bit	R/W	Default	Function
7-4	R	0	Reserved.
3	R/W	0	If this bit is set to one along with bit 0 is set to one, the 2051nt will drive the CPU output interface signals low so that the CPU's power can be powered-off.
2	R/W	0	If this bit is set to one along with bit 0 is set to one, the 2051nt will drive the PCI output interface signals low so that the PCI device's power can be powered-off.
1	R	0	If this bit is set to one along with bit 0 is set to one, the 2051nt will drive the ISA output interface signals low so that the ISA device's power can be powered-off.
0	R/W	0	When this bit and Register 41h, bit 0 are set to one, the power on suspend is enabled.

Note: Register 80h-81h are located in the north bridge. Since the power management control block is located in the south bridge, register 41h (page 98) should also be configured to control the CPU, PCI and ISA interfaces.

Register 81h

Bit	R/W	Default	Function
7	R/W	0	This bit selects the refresh source for the DRAM when the system is in suspend mode. If this bit is set to one, 32KHz clock source is selected to handle the DRAM refresh. The refresh request is selected when this bit is set to zero.
6	R/W	0	Set this bit to one to enable the self-refresh DRAM where 32KHz clock will be used to handle DRAM refresh. If this bit is zero, the /CAS before /RAS (normal DRAM) refresh will be used.
5-4	R/W	00	These bits select the slow refresh rate during power-on suspend mode. Bits Slow Refresh Rate 54 00 15us (assuming a 32KHz reference clock) 01 30us 10 60us 11 120us
3	R	0	Reserved.
2	R	0	Reserved for internal testing.
1-0	R/W	0	These bits select the recovery time (resume) from suspend mode. Bits Recovery Time 10 00 8ms (assuming a 32 KHz reference clock) 01 16ms 10 32ms 11 64ms

Power Output Control Register 82h

Bit	R/W	Default	Function
7-6	R	0	Reserved.
5	R/W	0	If this bit is set to one when the L2 cache is disabled, TAG [6:0] and DTY becomes output signal (see Reg. 8Ah).
4	R/W	0	When set to one TAG7 becomes PWROUT4 (pin B10), an output signal. The value to be output is put in Reg. 84h, bit 4.
3	R/W	0	Reserved.
2	R/W	1	When set to one /RAS3 becomes PWROUT2 (pin U3), an output signal. The value to be output is put in Register 84h, bit 2.
1	R/W	1	When set to one /RAS4 becomes PWROUT1 (pin U2), an output signal. The value to be output is put in Register 84h, bit 1.
0	R/W	1	When set to one KALE becomes PWROUT0 (pin E12), an output signal. The value to be output is put in Register 84h, bit 0.

Power Output Control Register 83h

This register control the output level (0/1 or off/ on) for the PWROUT [2..0] signals when the system entered the suspend mode. These signals can be used (with the external power transistor) to turn off the external device such as CPU, PCI, ISA power, etc. The power-on default value of the PWROUT [2..0] signals is 1 (on).

Bit	R/W	Default	Function
7	R	0	Reserved. Set to zero.
6	R/W	0	When register 80h, bit 2 is set to allow 2051nt to drive PCI output interface signals low, PWROUT2 signal becomes 0 (off) when this bit is set to one.
5	R/W	0	When register 80h, bit 2 is set to allow 2051nt to drive PCI output interface signals low, PWROUT1 signal becomes 0 (off) when this bit is set to one.
4	R/W	0	When register 80h, bit 2 is set to allow 2051nt to drive PCI output interface signals low, PWROUT0 signal becomes 0 (off) when this bit is set to one.
3	R	0	Reserved. Set to zero
2	R/W	0	When register 80h, bit 3 is set to allow 2051nt to drive CPU output interface signals low, PWROUT2 signal becomes 0 (off) when this bit is set to one.
1	R/W	0	When register 80h, bit 3 is set to allow 2051nt to drive CPU output interface signals low, PWROUT1 signal becomes 0 (off) when this bit is set to one.
0	R/W	0	When register 80h, bit 3 is set to allow 2051nt to drive CPU output interface signals low, PWROUT0 signal becomes 0 (off) when this bit is set to one.

Power Output Control Register 84h

Bit	R/W	Default	Function
7-5	R	0	Reserved. Set to zero.
4	R/W	1	When Reg. 82h, bit [4:0] are set to one, the value to be output can be put in this bit. (Default is 1). Writing a zero to bit 4 will make PWROUT4 equal to zero.
3	R	1	Reserved. Set to zero.
2	R/W	1	When Reg. 82h, bit [4:0] are set to one, the value to be output can be put in this bit. (Default is 1). Writing a zero to bit 2 will make PWROUT2 equal to zero.
1	R/W	1	When Reg. 82h, bit [4:0] are set one, the value to be output can be put in this bit. (Default is 1). Writing a zero to bit 1 will make PWROUT1 equal to zero.
0	R/W	1	When Reg. 82h, bit [4:0] are set one, the value to be output can be put in this bit. (Default is 1). Writing a zero to bit 0 will make PWROUT0 equal to zero.

4.3.2 GPIO, General Purpose I/O Control (Registers 85h-87h)

The GPIO [7:5] (pins B28, G27, and G28) and GPIO [2:0] (pins AJ11, AH11, and AG11) are general purpose I/O pins. Their direction is individually controlled by Register 86h, bits [7:5], [2:0]. A one to these bits indicates an output. The values to be output are put in Register 85h, bits [7:5] and bits [2:0]. While in input mode, their values can be read in Register 87h, bits [7:5] and bits [2:0].

Register 85h, General Purpose Output Port

Bit	R/W	Default	Function
7	R/W	0	A value (0 or 1) to be written to this GPIO7 output pin.
6	R/W	0	A value (0 or 1) to be written to this GPIO6 output pin.
5	R/W	0	A value (0 or 1) to be written to this GPIO5 output pin.
4-3	R	0	Reserved.
2	R/W	0	A value (0 or 1) to be written to this GPIO2 output pin.
1	R/W	0	A value (0 or 1) to be written to this GPIO1 output pin.
0	R/W	0	A value (0 or 1) to be written to this GPIO0 output pin.

Register 86h, General Purpose I/O Port

Bit	R/W	Default	Function
7	R/W	0	When this bit is set to 1, it indicates GPIO7 is an output pin. If it set to 0, then GPIO7 pin becomes an input.
6	R/W	0	When this bit is set to 1, it indicates GPIO6 is an output pin. If it set to 0, then GPIO6 pin becomes an input.
5	R/W	0	When this bit is set to 1, it indicates GPIO5 is an output pin. If it set to 0, then GPIO5 pin becomes an input.
4-3	R	0	Reserved.
2	R/W	0	When this bit is set to 1, it indicates GPIO2 is an output pin. If it set to 0, then GPIO2 pin becomes an input.
1	R/W	0	When this bit is set to 1, it indicates GPIO1 is an output pin. If it set to 0, then GPIO1 pin becomes an input.
0	R/W	0	When this bit is set to 1, it indicates GPIO0 is an output pin. If it set to 0, then GPIO0 pin becomes an input.

Register 87h, General Purpose Input Port

Bit	R/W	Default	Function
7	R	x	The state (0 or 1) on GPIO7 input pin can be read through this bit.
6	R	x	The state (0 or 1) on GPIO6 input pin can be read through this bit.
5	R	x	The state (0 or 1) on GPIO5 input pin can be read through this bit.
4-3	R	x	Reserved.
2	R	x	The state (0 or 1) on GPIO2 input pin can be read through this bit.
1	R	x	The state (0 or 1) on GPIO1 input pin can be read through this bit.
0	R	x	The state (0 or 1) on GPIO0 input pin can be read through this bit.

Status Input (register 88h-89h)

The status input register is a read only register. It can be used to read the status of the CPU or other device at any time.

Register 88h

Bit	R/W	Default	Function
7-5	R	0	Reserved.
4-0	R	x	KCSTS [4:0] = (/TAGWE, /TKA3, /TKA4, /KCS, /KOE). When the L2 cache is disabled (Register 74h, bits 2-0 are set to 000), these input signals and their values can be read from these bits accordingly).

Configuration Register 89h

Bit	R/W	Default	Function
7-0	R	x	KWSTS [7:0] = /KWE [7:0]. When the L2 cache is disabled (Register 74h, bits 2-0 are set to 000), these pin signals and their values can be read from these bits accordingly).

Tag Power Output**Register 8Ah**

Bit	R/W	Default	Function
7-0	R/W	1	TPWROUT [7:0] = DTY, TAG [6:0]. When Register 82h, bit 5 is set to one the DTY, TAG [6:0] becomes output signals. The values to be output are put in bits 7-0 accordingly.

4.4 Device 1, Function 0 Configuration Registers (PCI to ISA):**Standard PCI Ports****Vendor ID Register 0h, 1h (function 0)**

Bit	R/W	Default	Function
15-0	R	10AA	ACC Micro vendor Identification

Device ID Register 2h, 3h (function 0)

Bit	R/W	Default	Function
15-0	R	5842	ACC Micro device I.D.

PCI Command Register 4h, 5h (function 0)

Bit	R/W	Default	Function
15-0	R	000C	PCI local bus specification command register. Only bits 0,6 are R/W.

PCI Status Register 6h, 7h (function 0)

Bit	R/W	Default	Function
15-0	R	0400	PCI local bus specification status register

PCI Revision ID Register 8h (function 0)

Bit	R/W	Default	Function
7-0	R	00	PCI local bus specification revision ID register

Class Code Register 9h, Ah, Bh (function 0)

Bit	R/W	Default	Function
22-0	R	060100	PCI local bus specification class code register

Header Type Register Eh (function 0)

Bit	R/W	Default	Function
7-0	R	00	PCI local bus specification header type register

Interrupt Line Register 3Ch (function 0)

Bit	R/W	Default	Function
7-0	R/W	00	PCI local bus specification interrupt line register

Interrupt Pin Register 3Dh (function 0)

Bit	R/W	Default	Function
7-0	R	00	PCI local bus specification interrupt pin register

Note: All other registers (PCI Standard) between 00h & 3Fh are read only with default value 00.

Interrupt Route Control Registers 60h /INTA, 61h /INTB, 62h /INTC, 63h /INTD

Bit	R/W	Default	Function																																				
7	R/W	0	/INT(A, B, C, or D) interrupt routing enable.																																				
6-4	R	0	Reserved.																																				
3-0	R/W	0	/INT(A, B, C, or D) interrupt routing select. <table border="0"> <thead> <tr> <th>Bits</th> <th>IRQ Routing</th> </tr> </thead> <tbody> <tr> <td>3210</td> <td></td> </tr> <tr> <td>0000</td> <td>Reserved</td> </tr> <tr> <td>0001</td> <td>Reserved</td> </tr> <tr> <td>0010</td> <td>Reserved</td> </tr> <tr> <td>0011</td> <td>IRQ3</td> </tr> <tr> <td>0100</td> <td>IRQ4</td> </tr> <tr> <td>0101</td> <td>IRQ5</td> </tr> <tr> <td>0110</td> <td>IRQ6</td> </tr> <tr> <td>0111</td> <td>IRQ7</td> </tr> <tr> <td>1000</td> <td>Reserved</td> </tr> <tr> <td>1001</td> <td>IRQ9</td> </tr> <tr> <td>1010</td> <td>IRQ10</td> </tr> <tr> <td>1011</td> <td>IRQ11</td> </tr> <tr> <td>1100</td> <td>IRQ12</td> </tr> <tr> <td>1101</td> <td>Reserved</td> </tr> <tr> <td>1110</td> <td>IRQ14</td> </tr> <tr> <td>1111</td> <td>IRQ15</td> </tr> </tbody> </table>	Bits	IRQ Routing	3210		0000	Reserved	0001	Reserved	0010	Reserved	0011	IRQ3	0100	IRQ4	0101	IRQ5	0110	IRQ6	0111	IRQ7	1000	Reserved	1001	IRQ9	1010	IRQ10	1011	IRQ11	1100	IRQ12	1101	Reserved	1110	IRQ14	1111	IRQ15
Bits	IRQ Routing																																						
3210																																							
0000	Reserved																																						
0001	Reserved																																						
0010	Reserved																																						
0011	IRQ3																																						
0100	IRQ4																																						
0101	IRQ5																																						
0110	IRQ6																																						
0111	IRQ7																																						
1000	Reserved																																						
1001	IRQ9																																						
1010	IRQ10																																						
1011	IRQ11																																						
1100	IRQ12																																						
1101	Reserved																																						
1110	IRQ14																																						
1111	IRQ15																																						

4.4.1 ISA DMA Memory Region

Note: This register sets the memory range in which ISA DMA or MASTER memory cycles are forwarded to PCI. The range from 0C0000h to 0FFFFFFh can not be accessed by ISA DMA or MASTER.

Register 64h

Bit	R/W	Default	Function																																				
7	R	0	Reserved.																																				
6	R/W	0	Set to one to enable segment 0B0000h as ISA DMA Memory region.																																				
5	R/W	0	Set to one to enable segment 0A0000h as ISA DMA Memory region.																																				
4	R/W	0	Set to one to enable 512K base memory option. (default is 640K)																																				
3-0	R/W	0	DMA Memory region select. <table border="0"> <thead> <tr> <th>Bits</th> <th>Memory Region</th> </tr> </thead> <tbody> <tr> <td>3210</td> <td></td> </tr> <tr> <td>0000</td> <td>Below 1 MB</td> </tr> <tr> <td>0001</td> <td>Below 2 MB</td> </tr> <tr> <td>0010</td> <td>Below 3 MB</td> </tr> <tr> <td>0011</td> <td>Below 4 MB</td> </tr> <tr> <td>0100</td> <td>Below 5 MB</td> </tr> <tr> <td>0101</td> <td>Below 6 MB</td> </tr> <tr> <td>0110</td> <td>Below 7 MB</td> </tr> <tr> <td>0111</td> <td>Below 8 MB</td> </tr> <tr> <td>1000</td> <td>Below 9 MB</td> </tr> <tr> <td>1001</td> <td>Below 10 MB</td> </tr> <tr> <td>1010</td> <td>Below 11 MB</td> </tr> <tr> <td>1011</td> <td>Below 12 MB</td> </tr> <tr> <td>1100</td> <td>Below 13 MB</td> </tr> <tr> <td>1101</td> <td>Below 14 MB</td> </tr> <tr> <td>1110</td> <td>Below 15 MB</td> </tr> <tr> <td>1111</td> <td>Below 16 MB</td> </tr> </tbody> </table>	Bits	Memory Region	3210		0000	Below 1 MB	0001	Below 2 MB	0010	Below 3 MB	0011	Below 4 MB	0100	Below 5 MB	0101	Below 6 MB	0110	Below 7 MB	0111	Below 8 MB	1000	Below 9 MB	1001	Below 10 MB	1010	Below 11 MB	1011	Below 12 MB	1100	Below 13 MB	1101	Below 14 MB	1110	Below 15 MB	1111	Below 16 MB
Bits	Memory Region																																						
3210																																							
0000	Below 1 MB																																						
0001	Below 2 MB																																						
0010	Below 3 MB																																						
0011	Below 4 MB																																						
0100	Below 5 MB																																						
0101	Below 6 MB																																						
0110	Below 7 MB																																						
0111	Below 8 MB																																						
1000	Below 9 MB																																						
1001	Below 10 MB																																						
1010	Below 11 MB																																						
1011	Below 12 MB																																						
1100	Below 13 MB																																						
1101	Below 14 MB																																						
1110	Below 15 MB																																						
1111	Below 16 MB																																						

ROM Setup Register 65h

Bit	R/W	Default	Function
7	R	0	Reserved.
6	R/W	0	Set to one to enable /ROMCS for memory write.
5	R/W	0	Set to one to enable ROM to include the address range FFFE0000-FFFEFFFF.
4	R/W	0	Set to one to enable ROM to include the address range FFFD0000-FFFDFFFF.
3	R/W	0	Set to one to enable ROM to include the address range FFFC0000-FFFCFFFF.
2	R/W	0	Set to one to enable ROM to include the address range 000E0000-000EFFFF.
1	R/W	0	Set to one to enable ROM to include the address range 000D0000-000DFFFF.
0	R/W	0	Set to one to enable ROM to include the address range 000C0000-000CFFFF.

ISA Decode Control Register 66h

Bit	R/W	Default	Function										
7	R/W	0	Set this bit to 1 to enable the fast positive decode function. When this bit is 0, the ISA will be defaulted to slow positive decode.										
6	R/W	0	When this bit is 1, the 612 will be set to positive decode. The 612 is default to subtractive decode when this bit is 0.										
5	R/W	0	When this bit is 1, the 8237 DMA controller will be set to positive decode. The 8237 is default to subtractive decode when this bit is 0.										
4	R/W	0	When this bit is 1, the 8254 timer will be set to positive decode. The 8254 is default to subtractive decode when this bit is 0.										
3	R/W	0	When this bit is 1, the 8259 interrupt controller will be set to positive decode. The 8259 is default to subtractive decode when this bit is 0.										
2	R/W	0	When this bit is 1, the ROM space will be set to positive decode. The ROM space is default to subtractive decode when this bit is 0.										
1	R/W	0	Subtractive decode time selection. <table border="0"> <thead> <tr> <th>Bits</th> <th>Decode Time</th> </tr> </thead> <tbody> <tr> <td>10</td> <td></td> </tr> <tr> <td>00</td> <td>Slow</td> </tr> <tr> <td>01</td> <td>Medium</td> </tr> <tr> <td>1X</td> <td>Fast</td> </tr> </tbody> </table>	Bits	Decode Time	10		00	Slow	01	Medium	1X	Fast
Bits	Decode Time												
10													
00	Slow												
01	Medium												
1X	Fast												

I/O Recovery Control Register 67h

Bit	R/W	Default	Function																																																		
7	R	0	Reserved.																																																		
6	R/W	0	When this bit is 1 the slow I/O recovery time will be selected.																																																		
5-3	R/W	0	16-bit I/O recovery time selection. <table border="0"> <thead> <tr> <th colspan="5">I/O Recovery time</th> </tr> <tr> <th>Bit 5</th> <th>Bit 4</th> <th>Bit 3</th> <th>Bit 6=0</th> <th>Bit 6=1</th> </tr> </thead> <tbody> <tr> <td>0</td> <td>0</td> <td>0</td> <td>0</td> <td>0</td> </tr> <tr> <td>0</td> <td>0</td> <td>1</td> <td>1</td> <td>1</td> </tr> <tr> <td>0</td> <td>1</td> <td>0</td> <td>2</td> <td>5</td> </tr> <tr> <td>0</td> <td>1</td> <td>1</td> <td>3</td> <td>9</td> </tr> <tr> <td>1</td> <td>0</td> <td>0</td> <td>4</td> <td>13</td> </tr> <tr> <td>1</td> <td>0</td> <td>1</td> <td>5</td> <td>17</td> </tr> <tr> <td>1</td> <td>1</td> <td>0</td> <td>6</td> <td>21</td> </tr> <tr> <td>1</td> <td>1</td> <td>1</td> <td>7</td> <td>25</td> </tr> </tbody> </table>	I/O Recovery time					Bit 5	Bit 4	Bit 3	Bit 6=0	Bit 6=1	0	0	0	0	0	0	0	1	1	1	0	1	0	2	5	0	1	1	3	9	1	0	0	4	13	1	0	1	5	17	1	1	0	6	21	1	1	1	7	25
I/O Recovery time																																																					
Bit 5	Bit 4	Bit 3	Bit 6=0	Bit 6=1																																																	
0	0	0	0	0																																																	
0	0	1	1	1																																																	
0	1	0	2	5																																																	
0	1	1	3	9																																																	
1	0	0	4	13																																																	
1	0	1	5	17																																																	
1	1	0	6	21																																																	
1	1	1	7	25																																																	
2-0	R/W	0	8-bit I/O recovery time selection. <table border="0"> <thead> <tr> <th colspan="5">I/O Recovery time</th> </tr> <tr> <th>Bit 2</th> <th>Bit 1</th> <th>Bit 0</th> <th>Bit 6=0</th> <th>Bit 6=1</th> </tr> </thead> <tbody> <tr> <td>0</td> <td>0</td> <td>0</td> <td>0</td> <td>0</td> </tr> <tr> <td>0</td> <td>0</td> <td>1</td> <td>1</td> <td>1</td> </tr> <tr> <td>0</td> <td>1</td> <td>0</td> <td>2</td> <td>5</td> </tr> <tr> <td>0</td> <td>1</td> <td>1</td> <td>3</td> <td>9</td> </tr> <tr> <td>1</td> <td>0</td> <td>0</td> <td>4</td> <td>13</td> </tr> <tr> <td>1</td> <td>0</td> <td>1</td> <td>5</td> <td>17</td> </tr> <tr> <td>1</td> <td>1</td> <td>0</td> <td>6</td> <td>21</td> </tr> <tr> <td>1</td> <td>1</td> <td>1</td> <td>7</td> <td>25</td> </tr> </tbody> </table> <p>Note: The unit of I/O recovery is 8 MHz.</p>	I/O Recovery time					Bit 2	Bit 1	Bit 0	Bit 6=0	Bit 6=1	0	0	0	0	0	0	0	1	1	1	0	1	0	2	5	0	1	1	3	9	1	0	0	4	13	1	0	1	5	17	1	1	0	6	21	1	1	1	7	25
I/O Recovery time																																																					
Bit 2	Bit 1	Bit 0	Bit 6=0	Bit 6=1																																																	
0	0	0	0	0																																																	
0	0	1	1	1																																																	
0	1	0	2	5																																																	
0	1	1	3	9																																																	
1	0	0	4	13																																																	
1	0	1	5	17																																																	
1	1	0	6	21																																																	
1	1	1	7	25																																																	

ISA and Keyboard Control Register 68h

Bit	R/W	Default	Function
7	R/W	1	Set to one to enable the internal keyboard controller.
6	R/W	0	Set to one to disable the internal keyboard controller mouse port, i.e, multiplex pins MSDATA becomes IRQ12, and MSCLK becomes /KBCS .
5	R/W	0	This bit selects the color/mono switch for the internal keyboard controller.
4	R/W	0	Set to one to enable the AT refresh (default is disable.)
3	R/W	0	Set to one to enable zero wait 16-bit ISA cycle.
2	R/W	0	This bit is set to one to enable Device 1, Function 1. Default is disabled.
1	R/W	0	Reserved.
0	R/W	0	Reserved.

Clock Control Register 69h

Bit	R/W	Default	Function
7-6	R/W	0	Keyboard clock source select. Bits Clock Source 76 00 ISA Clock divided by 16 01 ISA Clock divided by 8 10 ISA Clock divided by 2 11 ISA Clock divided by 1
5	R/W	0	When this bit is set to 0, PCICLK = CLKSRC divided by 2. PCICLK = CLKSRC divided by 1.5 when set to 1.
4-0	R/W	0	ISA clock source select. Bits ISA Clock Source 43210 0XXXX X14M (default) 11XXX PCICLK divided by 2 10000 CLKSRC divided by 5 10001 CLKSRC divided by 3 10010 CLKSRC divided by 2.5 10011 CLKSRC divided by 1.5 10100 CLKSRC divided by 1 10101 CLKSRC divided by 4 10110 CLKSRC divided by 1 10111 CLKSRC divided by 2

4.4.2 Programmable Chip Select (Register 6Ch-73h)

ACC Micro 2051nt provides four programmable chip select signals, PCS[3:0], to support external I/O devices. The I/O addresses for the PCSx are decoded through register 6Ch-73h.

Programmable Chip Select (PCS0) Register 6Ch

Bit	R/W	Default	Function
7	R/W	0	When set to one, along with multiplex AT configuration Register 6h, bits 5-4 are set to [1:0], the PCS0 (pin C29) logic is enabled.
6	R/W	0	This bit is used to qualify PCS0 with IOW.
5	R/W	0	This bit is used to qualify PCS0 with IOR.
4	R/W	0	This bit is PCS0 address bit SA9.
3	R/W	0	This bit is PCS0 address bit SA8.
2	R/W	0	This bit is PCS0 address bit SA7.
1	R/W	0	This bit is PCS0 address bit SA6.
0	R/W	0	This bit is PCS0 address bit SA5.

Note: If both bits 5 and 6 are set, either IOR or IOW will activate the chip select. If both bits 5 and 6 are 0, programmable chip select will address decoding only, not qualified with command. (Default)

Programmable Chip Select (PCS0) Register 6Dh

Bit	R/W	Default	Function
7	R/W	0	This bit is PCS0 address bit SA4.
6	R/W	0	This bit is PCS0 address bit SA3.
5	R/W	0	This bit is PCS0 address bit SA2.
4	R/W	0	This bit is PCS0 address bit SA1.
3	R/W	0	When set to one this bit enables comparison of SA4 with PCS0 SA4.
2	R/W	0	When set to one this bit enables comparison of SA3 with PCS0 SA3.
1	R/W	0	When set to one this bit enables comparison of SA2 with PCS0 SA2.
0	R/W	0	When set to one this bit enables comparison of SA1 with PCS0 SA1.

Programmable Chip Select (PCS1) Register 6Eh

Bit	R/W	Default	Function
7	R/W	0	When set to one along with multiplex AT configuration register 6h, bits [3:2] are set to [1:1], the PCS1 (pin B29) logic is enabled.
6	R/W	0	This bit enables programmable chip select qualified with IOW.
5	R/W	0	This bit enables programmable chip select qualified with IOR.
4	R/W	0	This bit is PCS1 address bit SA9.
3	R/W	0	This bit is PCS1 address bit SA8.
2	R/W	0	This bit is PCS1 address bit SA7.
1	R/W	0	This bit is PCS1 address bit SA6.
0	R/W	0	This bit is PCS1 address bit SA5.

Note: If both bits 5 and 6 are set, either IOR or IOW will activate the chip select. If both bits 5 and 6 are 0, programmable chip select will be address decode only, not qualified with command.

Programmable Chip Select (PCS1) Register 6Fh

Bit	R/W	Default	Function
7	R/W	0	This bit is PCS1 address bit SA4.
6	R/W	0	This bit is PCS1 address bit SA3.
5	R/W	0	This bit is PCS1 address bit SA2.
4	R/W	0	This bit is PCS1 address bit SA1.
3	R/W	0	When set to one this bit enables comparison of SA4 with PCS1 SA4.
2	R/W	0	When set to one this bit enables comparison of SA3 with PCS1 SA3.
1	R/W	0	When set to one this bit enables comparison of SA2 with PCS1 SA2.
0	R/W	0	When set to one this bit enables comparison of SA1 with PCS1 SA1.

Programmable Chip Select (PCS2) Register 70h

Bit	R/W	Default	Function
7	R/W	0	When set to one along with multiplex AT configuration register 7h, bits [4,3,2] are set to [1,0,1], the PCS2 (pin K28) logic is enabled.
6	R/W	0	This bit is used to qualify PCS2 with IOW.
5	R/W	0	This bit is used to qualify PCS2 with IOR.
4	R/W	0	This bit is PCS2 address bit SA9.
3	R/W	0	This bit is PCS2 address bit SA8.
2	R/W	0	This bit is PCS2 address bit SA7.
1	R/W	0	This bit is PCS2 address bit SA6.
0	R/W	0	This bit is PCS2 address bit SA5.

Note: If both bits 5 and 6 are set, either IOR or IOW will activate the chip select. If both bits 5 and 6 are 0, programmable chip select will address decoding only, not qualified with command. (Default)

Programmable Chip Select (PCS2) Register 71h

Bit	R/W	Default	Function
7	R/W	0	This bit is PCS2 address bit SA4.
6	R/W	0	This bit is PCS2 address bit SA3.
5	R/W	0	This bit is PCS2 address bit SA2.
4	R/W	0	This bit is PCS2 address bit SA1.
3	R/W	0	When set to one this bit enables comparison of SA4 with PCS2 SA4.
2	R/W	0	When set to one this bit enables comparison of SA3 with PCS2 SA3.
1	R/W	0	When set to one this bit enables comparison of SA2 with PCS2 SA2.
0	R/W	0	When set to one this bit enables comparison of SA1 with PCS2 SA1.

Programmable Chip Select (PCS3) Register 72h

Bit	R/W	Default	Function
7	R/W	0	When set to one along with multiplex AT configuration register 7h, bits [4,0] are set to [1,1], the PCS3 (K29) logic is enabled.
6	R/W	0	This bit is used to qualify PCS3 with IOW.
5	R/W	0	This bit is used to qualify PCS3 with IOR.
4	R/W	0	This bit is PCS3 address bit SA9.
3	R/W	0	This bit is PCS3 address bit SA8.
2	R/W	0	This bit is PCS3 address bit SA7.
1	R/W	0	This bit is PCS3 address bit SA6.
0	R/W	0	This bit is PCS3 address bit SA5.

Note: If both bits 5 and 6 are 1, either IOR or IOW will activate the chip select. If both bits 5 and 6 are 0, programmable chip select will address decoding only, not qualified with command. (Default)

Programmable Chip Select (PCS3) Register 73h

Bit	R/W	Default	Function
7	R/W	0	This bit is PCS3 address bit SA4.
6	R/W	0	This bit is PCS3 address bit SA3.
5	R/W	0	This bit is PCS3 address bit SA2.
4	R/W	0	This bit is PCS3 address bit SA1.
3	R/W	0	When set to one this bit enables comparison of SA4 with PCS3 SA4.
2	R/W	0	When set to one this bit enables comparison of SA3 with PCS3 SA3.
1	R/W	0	When set to one this bit enables comparison of SA2 with PCS3 SA2.
0	R/W	0	When set to one this bit enables comparison of SA1 with PCS3 SA1.

Misc. Register 74h

Bit	R/W	Default	Function
7-4	R	0	Reserved.
3	R/W	0	When set to one F3 to be read from SD instead of XD. (When ACC Micro Super I/O controller is in use.)
2	R/W	0	Set to one to enable /CLKRUN protocol.
1	R/W	0	Set to one to enable Mobile PCI Serial Interrupt Protocol.
0	R/W	0	Set to one to enable Mobile PCI DMA Protocol.

/REQ & /GNT Control Register 1 (Mobile PC/PCI) Register 75h

Bit	R/W	Default	Function
7-4	R/W	0	/REQ1 & /GNT1 control registers.
3-0	R/W	0	/REQ0 & /GNT0 control registers.

/REQ & /GNT Control Register 2 (Mobile PC/PCI) Register 76h

Bit	R/W	Default	Function
7-4	R/W	0	/REQ3 & /GNT3 control registers.
3-0	R/W	0	/REQ2 & /GNT2 control registers.

4.4.3 Positive Decoded ISA Bus (Registers 78h-7Dh)

The 2051nt allows the ISA peripherals' addresses to be configured as the positive decoded agents for a complete ISA docking design.

Docking ISA Enable and ISA Peripherals (Positive Decode) Windows - Register 78h

Bit	R/W	Default	Function
7	R	0	Reserved.
6	R/W	0	When set to one I/O address 278h-27Fh or 678h-67Bh (for LPT3) will be set as positive decoded.
5	R/W	0	When set to one I/O address 378-37F or 778h-77Bh (for LPT2) will be set as positive decoded.
4	R/W	0	When set to one I/O address 3BCh-3BFh or 7BCh-7BFh (for LPT1) will be set as positive decoded.
3	R/W	0	When set to one I/O address A79h (for Plug and Play device) will be set as positive decoded.
2	R/W	0	When set to one I/O address 200h-207h (for Joystick) will be set as positive decoded.
1	R/W	0	When set to one the special cycle interrupt acknowledge cycle will be claimed by the on-board ISA block where the interrupt controller resides.
0	R/W	0	When set to one the ACC Micro 2051nt will not be set to subtractive decode. The ACC Micro 2051nt is defaulted to subtractive decode when set to zero . (Certain ISA windows can be set to positive decode by programming Registers 78h-7Dh).

ISA Peripherals (Positive Decode) Windows - Register 79h

Bit	R/W	Default	Function
7	R/W	0	When set to one GCS3 will be set as positive decoded.
6	R/W	0	When set to one GCS2 will be set as positive decoded.
5	R/W	0	When set to one GCS1 will be set as positive decoded.
4	R/W	0	When set to one GCS0 will be set as positive decoded.
3	R/W	0	When set to one I/O address 2E8h-2EFh (for COM 4) will be set as positive decoded.
2	R/W	0	When set to one I/O address 3E8h-3EFh (for COM 3) will be set as positive decoded.
1	R/W	0	When set to one I/O address 2F8h-2FFh (for COM 2) will be set as positive decoded.
0	R/W	0	When set to one I/O address 3F8h-3FFh (for COM 1) will be set as positive decoded.

ISA Peripherals (Positive Decode) Windows - Register 7Ah

Bit	R/W	Default	Function
7	R/W	0	When set to one I/O address 092h (for Port 92) will be set as positive decoded.
6	R/W	0	When set to one I/O address 060h and 064h (for 8742) will be set as positive decoded.
5	R/W	0	When set to one I/O address 070h and 078h or 071h and 079h (for RTC) will be set as positive decoded.
4	R/W	0	When set to one I/O address PCS1 (programmable chip select 1) will be set as positive decoded.
3	R/W	0	When set to one I/O address PCS0 (programmable chip select 0) will be set as positive decoded.
2	R/W	0	When set to one I/O address 370h-375h or 377h (for secondary FDC) will be set as positive decoded.
1	R/W	0	When set to one I/O address 3F0h-3F5h or 3F7h (for primary FDC) will be set as positive decoded.
0	R/W	0	When set to one I/O address 3E0h-3E1h (for PCMCIA device) will be set as positive decoded.

ISA Peripherals (Positive Decode) Windows - Register 7Bh

Bit	R/W	Default	Function
7	R/W	0	When set to one programmable memory range CC000h-CFFFFh will be set as positive decoded.
6	R/W	0	When set to one programmable memory range C8000h-CBFFFh will be set as positive decoded.
5	R/W	0	When set to one programmable memory range C4000h-C7FFFh will be set as positive decoded.
4	R/W	0	When set to one programmable memory range C0000h-C3FFFh will be set as positive decoded.
3	R/W	0	When set to one the I/O address 4D0h and 4D1h (for IRQ edge/level select) will be set as positive decoded.
2	R/W	0	When set to one the I/O address 0F2h and 0F3h (for ACC Micro ISA configuration register setting) will be set as positive decoded.
1	R/W	0	When set to one the I/O address 0F0h (for co-processor) will be set as positive decoded.
0	R/W	0	When set to one the I/O address 061h (for Port B) will be set as positive decoded.

ISA Peripherals (Positive Decode) Windows - Register 7Ch

Bit	R/W	Default	Function
7	R/W	0	When set to one programmable memory range EC000h-EFFFFh will be set as positive decoded.
6	R/W	0	When set to one programmable memory range E8000h-EBFFFh will be set as positive decoded.
5	R/W	0	When set to one programmable memory range E4000h-E7FFFh will be set as positive decoded.
4	R/W	0	When set to one programmable memory range E0000h-E3FFFh will be set as positive decoded.
3	R/W	0	When set to one programmable memory range DC000h-DFFFFh will be set as positive decoded.
2	R/W	0	When set to one programmable memory range D8000h-DBFFFh will be set as positive decoded.
1	R/W	0	When set to one programmable memory range D4000h-D3FFFh will be set as positive decoded.
0	R/W	0	When set to one programmable memory range D0000h-D3FFFh will be set as positive decoded.

ISA Peripherals (Positive Decode) Windows - Register 7Dh

Bit	R/W	Default	Function
7-5	R/W	0	ISA peripheral positive decoded windows setting (for Sound Blaster). Bits 765 000 Disable 001 I/O address 210h 010 I/O address 220h 011 I/O address 230h 100 I/O address 240h 101 I/O address 250h 110 I/O address 260h 111 Disable
4	R/W	0	When set to one I/O address 388h-38Bh (for FM synthesizer) will be set as positive decoded.
3-2	R/W	0	ISA Peripheral Positive Decoded Windows setting (for Midi UART) Bits 32 00 I/O address 300h 01 I/O address 310h 10 I/O address 320h 11 I/O address 330h
1	R/W	0	When set to one the Midi Uart positive decode window is enabled.
0	R/W	0	When set to one the I/O address 201h (for audio setup base) will be set as positive decoded.

4.5 Device 1, Function1 Configuration Register (IDE Interface):**Standard PCI Ports****Vendor ID Register 0h, 1h (function 1)**

Bit	R/W	Default	Function
15-0	R	10AA	ACC Micro vendor identification

Device ID Register 2h, 3h (function 1)

Bit	R/W	Default	Function
15-0	R	5842	ACC Micro device I.D.

PCI Command Register 4h, 5h (function 1)

Bit	R/W	Default	Function
15-0	R	0000	PCI local bus specification command register. Only bits 0,6 are R/W.

PCI Status Register 6h, 7h (function 1)

Bit	R/W	Default	Function
15-0	R	0280	PCI local bus specification status register

PCI Revision ID Register 8h (function 1)

Bit	R/W	Default	Function
7-0	R	00	PCI local bus specification revision ID register

Class Code Register 9h, Ah, Bh (function 1)

Bit	R/W	Default	Function
22-0	R	010100	PCI local bus specification class code register

Header Type Register Eh (function 1)

Bit	R/W	Default	Function
7-0	R	00	PCI local bus specification header type register

Interrupt Line Register 3Ch (function 1)

Bit	R/W	Default	Function
7-0	R/W	00	PCI local bus specification interrupt line register

Interrupt Pin Register 3Dh (function 1)

Bit	R/W	Default	Function
7-0	R	00	PCI local bus specification interrupt pin register

Note: All other registers (PCI Standard) between 00h and 3Fh are read only with default value 00.

4.5.1 PCI IDE Control Register 40h

Bit	R/W	Default	Function												
7	R/W	0	/DEVSEL fast timing. When set to zero /DEVSEL will be asserted two clocks after /FRAME is asserted. When set to one /DEVSEL will be asserted one clock after /FRAME is asserted.												
6	R	0	Reserved.												
5-4	R/W	0	Read Prefetch Buffer select. <table> <thead> <tr> <th>Bits</th> <th>Prefetch Buffer (32/16 bit access)</th> </tr> </thead> <tbody> <tr> <td>54</td> <td></td> </tr> <tr> <td>00</td> <td>Disabled</td> </tr> <tr> <td>01</td> <td>1 DWORD/WORD Deep</td> </tr> <tr> <td>10</td> <td>2 DWORD/WORD Deep</td> </tr> <tr> <td>11</td> <td>4 DWORD/WORD Deep</td> </tr> </tbody> </table>	Bits	Prefetch Buffer (32/16 bit access)	54		00	Disabled	01	1 DWORD/WORD Deep	10	2 DWORD/WORD Deep	11	4 DWORD/WORD Deep
Bits	Prefetch Buffer (32/16 bit access)														
54															
00	Disabled														
01	1 DWORD/WORD Deep														
10	2 DWORD/WORD Deep														
11	4 DWORD/WORD Deep														
3	R/W	0	Set to one to enable the posted write feature for the PCI IDE function.												
2	R/W	0	Fast 8-bit IDE port timing. When set to zero, access to an 8-bit IDE port will use standard ISA timing. When set to one access to an 8-bit IDE port will use timing defined in Reg. 42h & 43h.												
1	R/W	0	Set to one to select I/O address 170-177, 376h for the secondary PCI IDE.												
0	R/W	0	Set to one to select I/O address 1F0-1F7, 3F6h for the primary PCI IDE.												

8-bit Timing Control, Recovery Time & Command Width Register 42h

Bit	R/W	Default	Function																																				
7-4	R/W	0	Command recovery time select for 8-bit I/O access. <table> <thead> <tr> <th>Bits</th> <th>Recovery time (cycles)</th> </tr> </thead> <tbody> <tr> <td>7654</td> <td></td> </tr> <tr> <td>0000</td> <td>1</td> </tr> <tr> <td>0001</td> <td>2</td> </tr> <tr> <td>0010</td> <td>3</td> </tr> <tr> <td>0011</td> <td>4</td> </tr> <tr> <td>0100</td> <td>5</td> </tr> <tr> <td>0101</td> <td>6</td> </tr> <tr> <td>0110</td> <td>7</td> </tr> <tr> <td>0111</td> <td>8</td> </tr> <tr> <td>1000</td> <td>9</td> </tr> <tr> <td>1001</td> <td>10</td> </tr> <tr> <td>1010</td> <td>11</td> </tr> <tr> <td>1011</td> <td>12</td> </tr> <tr> <td>1100</td> <td>13</td> </tr> <tr> <td>1101</td> <td>14</td> </tr> <tr> <td>1110</td> <td>15</td> </tr> <tr> <td>1111</td> <td>16</td> </tr> </tbody> </table>	Bits	Recovery time (cycles)	7654		0000	1	0001	2	0010	3	0011	4	0100	5	0101	6	0110	7	0111	8	1000	9	1001	10	1010	11	1011	12	1100	13	1101	14	1110	15	1111	16
Bits	Recovery time (cycles)																																						
7654																																							
0000	1																																						
0001	2																																						
0010	3																																						
0011	4																																						
0100	5																																						
0101	6																																						
0110	7																																						
0111	8																																						
1000	9																																						
1001	10																																						
1010	11																																						
1011	12																																						
1100	13																																						
1101	14																																						
1110	15																																						
1111	16																																						

8-bit Timing Control, Recovery Time & Command Width - Register 42h

Bit	R/W	Default	Function																																				
3-0	R/W	0	Command width select for 8-bit I/O access. <table> <thead> <tr> <th>Bits</th> <th>Command Width</th> </tr> <tr> <th>3210</th> <th>(cycles)</th> </tr> </thead> <tbody> <tr><td>0000</td><td>1</td></tr> <tr><td>0001</td><td>2</td></tr> <tr><td>0010</td><td>3</td></tr> <tr><td>0011</td><td>4</td></tr> <tr><td>0100</td><td>5</td></tr> <tr><td>0101</td><td>6</td></tr> <tr><td>0110</td><td>7</td></tr> <tr><td>0111</td><td>8</td></tr> <tr><td>1000</td><td>9</td></tr> <tr><td>1001</td><td>10</td></tr> <tr><td>1010</td><td>11</td></tr> <tr><td>1011</td><td>12</td></tr> <tr><td>1100</td><td>13</td></tr> <tr><td>1101</td><td>14</td></tr> <tr><td>1110</td><td>15</td></tr> <tr><td>1111</td><td>16</td></tr> </tbody> </table>	Bits	Command Width	3210	(cycles)	0000	1	0001	2	0010	3	0011	4	0100	5	0101	6	0110	7	0111	8	1000	9	1001	10	1010	11	1011	12	1100	13	1101	14	1110	15	1111	16
Bits	Command Width																																						
3210	(cycles)																																						
0000	1																																						
0001	2																																						
0010	3																																						
0011	4																																						
0100	5																																						
0101	6																																						
0110	7																																						
0111	8																																						
1000	9																																						
1001	10																																						
1010	11																																						
1011	12																																						
1100	13																																						
1101	14																																						
1110	15																																						
1111	16																																						

8-Bit Timing Control, Hold Time & Setup Time - Register 43h

Bit	R/W	Default	Function												
7-4	R	0	Reserved.												
3-2	R/W	0	Data hold time for 8-bit I/O access select. <table> <thead> <tr> <th>Bits</th> <th>Hold Time</th> </tr> <tr> <th>32</th> <th>(cycles)</th> </tr> </thead> <tbody> <tr><td>00</td><td>1</td></tr> <tr><td>01</td><td>2</td></tr> <tr><td>10</td><td>3</td></tr> <tr><td>11</td><td>4</td></tr> </tbody> </table>	Bits	Hold Time	32	(cycles)	00	1	01	2	10	3	11	4
Bits	Hold Time														
32	(cycles)														
00	1														
01	2														
10	3														
11	4														
1-0	R/W	0	Address setup time for 8-bit I/O access select. <table> <thead> <tr> <th>Bits</th> <th>Setup Time</th> </tr> <tr> <th>32</th> <th>(cycles)</th> </tr> </thead> <tbody> <tr><td>00</td><td>1</td></tr> <tr><td>01</td><td>2</td></tr> <tr><td>10</td><td>3</td></tr> <tr><td>11</td><td>4</td></tr> </tbody> </table>	Bits	Setup Time	32	(cycles)	00	1	01	2	10	3	11	4
Bits	Setup Time														
32	(cycles)														
00	1														
01	2														
10	3														
11	4														

Primary IDE Drive 0 Timing Control, Command Width - Registers 44h (1F0, drive 0), 45h (1F0, drive 1), 46h (170, drive 0), and 47h (170, drive 1)

Bit	R/W	Default	Function																																				
7-4	R/W	0	<p>IOR width select for primary IDE (1F0) drives 0 and 1 and secondary IDE (170) drives 0 and 1.</p> <table> <thead> <tr> <th>Bits</th> <th>Command Width (cycles)</th> </tr> </thead> <tbody> <tr><td>7654</td><td></td></tr> <tr><td>0000</td><td>1</td></tr> <tr><td>0001</td><td>2</td></tr> <tr><td>0010</td><td>3</td></tr> <tr><td>0011</td><td>4</td></tr> <tr><td>0100</td><td>5</td></tr> <tr><td>0101</td><td>6</td></tr> <tr><td>0110</td><td>7</td></tr> <tr><td>0111</td><td>8</td></tr> <tr><td>1000</td><td>9</td></tr> <tr><td>1001</td><td>10</td></tr> <tr><td>1010</td><td>11</td></tr> <tr><td>1011</td><td>12</td></tr> <tr><td>1100</td><td>13</td></tr> <tr><td>1101</td><td>14</td></tr> <tr><td>1110</td><td>15</td></tr> <tr><td>1111</td><td>16</td></tr> </tbody> </table>	Bits	Command Width (cycles)	7654		0000	1	0001	2	0010	3	0011	4	0100	5	0101	6	0110	7	0111	8	1000	9	1001	10	1010	11	1011	12	1100	13	1101	14	1110	15	1111	16
Bits	Command Width (cycles)																																						
7654																																							
0000	1																																						
0001	2																																						
0010	3																																						
0011	4																																						
0100	5																																						
0101	6																																						
0110	7																																						
0111	8																																						
1000	9																																						
1001	10																																						
1010	11																																						
1011	12																																						
1100	13																																						
1101	14																																						
1110	15																																						
1111	16																																						
3-0	R/W	0	<p>IOW width select for primary IDE (1F0) drives 0 and 1 and secondary IDE (170) drives 0 and 1.</p> <table> <thead> <tr> <th>Bits</th> <th>Command Width (cycles)</th> </tr> </thead> <tbody> <tr><td>3210</td><td></td></tr> <tr><td>0000</td><td>1</td></tr> <tr><td>0001</td><td>2</td></tr> <tr><td>0010</td><td>3</td></tr> <tr><td>0011</td><td>4</td></tr> <tr><td>0100</td><td>5</td></tr> <tr><td>0101</td><td>6</td></tr> <tr><td>0110</td><td>7</td></tr> <tr><td>0111</td><td>8</td></tr> <tr><td>1000</td><td>9</td></tr> <tr><td>1001</td><td>10</td></tr> <tr><td>1010</td><td>11</td></tr> <tr><td>1011</td><td>12</td></tr> <tr><td>1100</td><td>13</td></tr> <tr><td>1101</td><td>14</td></tr> <tr><td>1110</td><td>15</td></tr> <tr><td>1111</td><td>16</td></tr> </tbody> </table>	Bits	Command Width (cycles)	3210		0000	1	0001	2	0010	3	0011	4	0100	5	0101	6	0110	7	0111	8	1000	9	1001	10	1010	11	1011	12	1100	13	1101	14	1110	15	1111	16
Bits	Command Width (cycles)																																						
3210																																							
0000	1																																						
0001	2																																						
0010	3																																						
0011	4																																						
0100	5																																						
0101	6																																						
0110	7																																						
0111	8																																						
1000	9																																						
1001	10																																						
1010	11																																						
1011	12																																						
1100	13																																						
1101	14																																						
1110	15																																						
1111	16																																						

Primary IDE Drive 0 Timing Control, Recovery Time - Register 48h (1F0, drive 0), 49h (1F0, drive 1), 4Ah (170, drive 0), and 4Bh (170, drive 1)

Bit	R/W	Default	Function																																				
7-4	R/W	0	<p>IOR recovery time for primary IDE (1F0) drive 0 and 1 and secondary IDE (170) drives 0 and 1.</p> <table border="0"> <thead> <tr> <th>Bits</th> <th>Recovery time (cycles)</th> </tr> </thead> <tbody> <tr><td>7654</td><td></td></tr> <tr><td>0000</td><td>1</td></tr> <tr><td>0001</td><td>2</td></tr> <tr><td>0010</td><td>3</td></tr> <tr><td>0011</td><td>4</td></tr> <tr><td>0100</td><td>5</td></tr> <tr><td>0101</td><td>6</td></tr> <tr><td>0110</td><td>7</td></tr> <tr><td>0111</td><td>8</td></tr> <tr><td>1000</td><td>9</td></tr> <tr><td>1001</td><td>10</td></tr> <tr><td>1010</td><td>11</td></tr> <tr><td>1011</td><td>12</td></tr> <tr><td>1100</td><td>13</td></tr> <tr><td>1101</td><td>14</td></tr> <tr><td>1110</td><td>15</td></tr> <tr><td>1111</td><td>16</td></tr> </tbody> </table>	Bits	Recovery time (cycles)	7654		0000	1	0001	2	0010	3	0011	4	0100	5	0101	6	0110	7	0111	8	1000	9	1001	10	1010	11	1011	12	1100	13	1101	14	1110	15	1111	16
Bits	Recovery time (cycles)																																						
7654																																							
0000	1																																						
0001	2																																						
0010	3																																						
0011	4																																						
0100	5																																						
0101	6																																						
0110	7																																						
0111	8																																						
1000	9																																						
1001	10																																						
1010	11																																						
1011	12																																						
1100	13																																						
1101	14																																						
1110	15																																						
1111	16																																						
3-0	R/W	0	<p>IOW recovery time for primary IDE (1F0) drive 0 and 1 and secondary IDE (170) drives 0 and 1.</p> <table border="0"> <thead> <tr> <th>Bits</th> <th>Recovery Time (cycles)</th> </tr> </thead> <tbody> <tr><td>3210</td><td></td></tr> <tr><td>0000</td><td>1</td></tr> <tr><td>0001</td><td>2</td></tr> <tr><td>0010</td><td>3</td></tr> <tr><td>0011</td><td>4</td></tr> <tr><td>0100</td><td>5</td></tr> <tr><td>0101</td><td>6</td></tr> <tr><td>0110</td><td>7</td></tr> <tr><td>0111</td><td>8</td></tr> <tr><td>1000</td><td>9</td></tr> <tr><td>1001</td><td>10</td></tr> <tr><td>1010</td><td>11</td></tr> <tr><td>1011</td><td>12</td></tr> <tr><td>1100</td><td>13</td></tr> <tr><td>1101</td><td>14</td></tr> <tr><td>1110</td><td>15</td></tr> <tr><td>1111</td><td>16</td></tr> </tbody> </table>	Bits	Recovery Time (cycles)	3210		0000	1	0001	2	0010	3	0011	4	0100	5	0101	6	0110	7	0111	8	1000	9	1001	10	1010	11	1011	12	1100	13	1101	14	1110	15	1111	16
Bits	Recovery Time (cycles)																																						
3210																																							
0000	1																																						
0001	2																																						
0010	3																																						
0011	4																																						
0100	5																																						
0101	6																																						
0110	7																																						
0111	8																																						
1000	9																																						
1001	10																																						
1010	11																																						
1011	12																																						
1100	13																																						
1101	14																																						
1110	15																																						
1111	16																																						

IDE Timing Control, Setup Time - Register 4Ch

Bit	R/W	Default	Function												
7-6	R/W	0	Address setup time for secondary IDE (170) drive 1. <table> <thead> <tr> <th>Bits</th> <th>Setup Time (cycles)</th> </tr> </thead> <tbody> <tr> <td>76</td> <td>1</td> </tr> <tr> <td>00</td> <td>2</td> </tr> <tr> <td>01</td> <td>3</td> </tr> <tr> <td>10</td> <td>4</td> </tr> <tr> <td>11</td> <td></td> </tr> </tbody> </table>	Bits	Setup Time (cycles)	76	1	00	2	01	3	10	4	11	
Bits	Setup Time (cycles)														
76	1														
00	2														
01	3														
10	4														
11															
5-4	R/W	0	Address setup time for secondary IDE (170) drive 0. <table> <thead> <tr> <th>Bits</th> <th>Setup Time (cycles)</th> </tr> </thead> <tbody> <tr> <td>54</td> <td>1</td> </tr> <tr> <td>00</td> <td>2</td> </tr> <tr> <td>01</td> <td>3</td> </tr> <tr> <td>10</td> <td>4</td> </tr> <tr> <td>11</td> <td></td> </tr> </tbody> </table>	Bits	Setup Time (cycles)	54	1	00	2	01	3	10	4	11	
Bits	Setup Time (cycles)														
54	1														
00	2														
01	3														
10	4														
11															
3-2	R/W	0	Address setup time for primary IDE (1F0), drive 1. <table> <thead> <tr> <th>Bits</th> <th>Setup Time (cycles)</th> </tr> </thead> <tbody> <tr> <td>32</td> <td>1</td> </tr> <tr> <td>00</td> <td>2</td> </tr> <tr> <td>01</td> <td>3</td> </tr> <tr> <td>10</td> <td>4</td> </tr> <tr> <td>11</td> <td></td> </tr> </tbody> </table>	Bits	Setup Time (cycles)	32	1	00	2	01	3	10	4	11	
Bits	Setup Time (cycles)														
32	1														
00	2														
01	3														
10	4														
11															
1-0	R/W	0	Address setup time for primary IDE (1F0), drive 0. <table> <thead> <tr> <th>Bits</th> <th>Setup Time (cycles)</th> </tr> </thead> <tbody> <tr> <td>10</td> <td>1</td> </tr> <tr> <td>00</td> <td>2</td> </tr> <tr> <td>01</td> <td>3</td> </tr> <tr> <td>10</td> <td>4</td> </tr> <tr> <td>11</td> <td></td> </tr> </tbody> </table>	Bits	Setup Time (cycles)	10	1	00	2	01	3	10	4	11	
Bits	Setup Time (cycles)														
10	1														
00	2														
01	3														
10	4														
11															

IDE Timing Control, Hold Time - Register 4Dh

Bit	R/W	Default	Function												
7-6	R/W	0	Data hold time for secondary IDE (170) drive 1. <table> <thead> <tr> <th>Bits</th> <th>Hold Time (cycles)</th> </tr> </thead> <tbody> <tr> <td>76</td> <td>1</td> </tr> <tr> <td>00</td> <td>2</td> </tr> <tr> <td>01</td> <td>3</td> </tr> <tr> <td>10</td> <td>4</td> </tr> <tr> <td>11</td> <td></td> </tr> </tbody> </table>	Bits	Hold Time (cycles)	76	1	00	2	01	3	10	4	11	
Bits	Hold Time (cycles)														
76	1														
00	2														
01	3														
10	4														
11															
5-4	R/W	0	Data hold time for secondary IDE (170) drive 0. <table> <thead> <tr> <th>Bits</th> <th>Hold Time (cycles)</th> </tr> </thead> <tbody> <tr> <td>54</td> <td>1</td> </tr> <tr> <td>00</td> <td>2</td> </tr> <tr> <td>01</td> <td>3</td> </tr> <tr> <td>10</td> <td>4</td> </tr> <tr> <td>11</td> <td></td> </tr> </tbody> </table>	Bits	Hold Time (cycles)	54	1	00	2	01	3	10	4	11	
Bits	Hold Time (cycles)														
54	1														
00	2														
01	3														
10	4														
11															
3-2	R/W	0	Data hold time for primary IDE (1F0), drive 1. <table> <thead> <tr> <th>Bits</th> <th>Hold Time (cycles)</th> </tr> </thead> <tbody> <tr> <td>32</td> <td>1</td> </tr> <tr> <td>00</td> <td>2</td> </tr> <tr> <td>01</td> <td>3</td> </tr> <tr> <td>10</td> <td>4</td> </tr> <tr> <td>11</td> <td></td> </tr> </tbody> </table>	Bits	Hold Time (cycles)	32	1	00	2	01	3	10	4	11	
Bits	Hold Time (cycles)														
32	1														
00	2														
01	3														
10	4														
11															
1-0	R/W	0	Data hold time for primary IDE (1F0), drive 0. <table> <thead> <tr> <th>Bits</th> <th>Hold Time (cycles)</th> </tr> </thead> <tbody> <tr> <td>10</td> <td>1</td> </tr> <tr> <td>00</td> <td>2</td> </tr> <tr> <td>01</td> <td>3</td> </tr> <tr> <td>10</td> <td>4</td> </tr> <tr> <td>11</td> <td></td> </tr> </tbody> </table>	Bits	Hold Time (cycles)	10	1	00	2	01	3	10	4	11	
Bits	Hold Time (cycles)														
10	1														
00	2														
01	3														
10	4														
11															

4.6 Standard AT Configuration Registers (Power Management Mode):

4.6.1 System Management Interrupt (SMI) Enable

SMI Enable Register 0h

Bit	R/W	Default	Function
7	R/W	0	When this bit is 0, /SMI will not generate when the general purpose timer expired. /SMI will be generated when the general purpose timer expired if this bit is set to 1.
6	R/W	0	When this bit is 0, the /ACPWR input pin can not cause an SMI to occur. If this bit is set to 1, then the transitions of the /ACPWR input will cause an SMI.
5	R/W	0	When this bit is 0, the SMI will not occur when the emulate temperature (defined in reg. 50h-53h) reached the high or low limit. If this bit is set to 1 then SMI will be generated when the temperature reached the high or low limit.
4	R/W	0	When this bit is 0 the (software) SMI will not occur. Writing a 1 to this bit and a 1 to register 3Eh, bit 0 will cause the an SMI to occur.
3	R/W	0	When this bit is 0, the EXTSMI[0..2] input pins can not cause the SMI's to occur. If this bit is set to 1, then the transitions of the EXTSMI[0.. 2] inputs will cause the SMI's (which control by register 3Ch bit [0..2]).
2	R/W	0	When this bit is set to 1, the transition of the /SRBTN input bin, the auto suspend timer expired (control by register 40h,41h, and 43h), or the battery low timer expired (control by register 45h) will cause the SMI's to occur. If this bit is set to 0, the SMI's will not occur under the suspend mode.
1	R/W	0	When this bit is set to 1, an SMI will occur when the global standby timer expired (control by register 30h-35h). If this bit is set to 0, an SMI will not occur when the global standby timer expired.
0	R/W	0	When this bit is set to 1, the SMI's will occur when the local standby timer expired (control by register 2Bh-2Eh). If this bit is set to 0, an SMI will not occur when the local standby timer expired.

SMI Source 0 Register 2h

Bit	R/W	Default	Function
7	R/W	0	When a one is read, it indicates an SMI is requested from serial SMI of mobile PCI.
6-5	R	0	Reserved.
4	R/W	0	When a one is read, it indicates an SMI is generated from the general purpose timer
3	R/W	0	When a one is read, it indicates an SMI is requested to exit from GCS1 L.S. mode.
2	R/W	0	When a one is read, it indicates an SMI is requested to enter GCS1 L.S. mode.
1	R/W	0	When a one is read, it indicates an SMI is requested to exit from GCS0 L.S. mode.
0	R/W	0	When a one is read, it indicates an SMI is requested to enter GCS0 L.S. mode.

SMI Source 1 Register 3h

Bit	R/W	Default	Function
7	R/W	0	When a one is read, it indicates an SMI is requested from /SRBTN input pin.
6	R/W	0	When a one is read, it indicates an SMI is requested from /BATLOW0 input pin.
5	R/W	0	When a one is read, it indicates an SMI is requested to exit from auto Suspend mode.
4	R/W	0	When a one is read, it indicates an SMI is requested to enter auto Suspend mode.
3	R/W	0	When a one is read, it indicates an SMI is requested to exit from G. S. mode.
2	R/W	0	When a one is read, it indicates an SMI is requested to enter G.S. mode.
1	R/W	0	When a one is read, it indicates an SMI is requested to exit from LCD L.S. mode.
0	R/W	0	When set to one this bit enables request to enter LCD's L.S. mode.

SMI Source 2 Register 4h

Bit	R/W	Default	Function
7	R/W	0	When a one is read, it indicates an SMI is requested from temperature controller (high limit).
6	R/W	0	When a one is read, it indicates an SMI is requested from temperature controller (low limit).
5	R/W	0	When a one is read, it indicates an SMI is requested from a high to low transition of ACPWR input pin.
4	R/W	0	When a one is read, it indicates an SMI is requested from a low to high transition of ACPWR input pin.
3	R/W	0	When a one is read, it indicates an SMI is requested from /EXTSMI2 input pin.
2	R/W	0	When a one is read, it indicates an SMI is requested from /EXTSMI1 input pin.
1	R/W	0	When a one is read, it indicates an SMI is requested from /EXTSMI0 input pin.
0	R/W	0	When a one is read, it indicates an SMI is requested from software SMI.

Global Control 0 Register 6h

Bit	R/W	Default	Function
7	R/W	0	When set to one, the power management control timer will switch from X14 (14.318MHz) to an external 32KHz (input pin Y29) as its clock source.
6	R/W	0	When set to one this bit disables all trigger sources of auto suspend timer/battery low and global standby system event timer.
5-4	R/W	0	These 2 bits are used to select the function of the multiplexed pin C29. Bits Function 5 4 0 0 Power Control 0 (default) 0 1 /LTCH0 (for power control bit 0-7) 1 0 /PCS0 (programmable chip select 0) 1 1 Reserved.
3-2	R/W	0	These 2 bits are used to select the function of the multiplexed pin B29. Bits Function 3 2 0 0 Power Control 1 (default) 0 1 /LTCH1 (for power control bit 8-15) 1 0 /DOZE (pin) 1 1 /PCS1 (programmable chip select 1)
1	R/W	0	This bit is used to select the function of the multiplexed pin C28. When it set to 0 it is the EXTSYS, external system event input pin. When it set to 1 it becomes the external sensor input pin, i.e., when this pin is asserted low (from the external source such as thermal sensor) the throttle mode will be enabled automatically.
0	R/W	0	When the SMI occurs, the 2051nt will keep the /SMI signal low until it got clear. Therefore this bit needs to be set to 1 before jumping out of the SMI handler to allow another SMI to get service.

Global Control 1 Register 7h

Bit	R/W	Default	Function
7-6	R/W	0	In the power on suspend, the CPU, PCI, and ISA interface will be driven low (refer to register 41h) so that their power can be turn off. The ACC Micro 2051nt will generate CPURST upon resume. Therefore this bit is used to select the reset period upon resume from power-on suspend. Bits Reset Period 7 6 0 x 1s (default) 1 0 512 ms 1 1 2s
5	R/W	0	Function for the multiplexed pin DACKx/PWRx . When set to one, DACK7 becomes PWR9, DACK6 becomes PWR8, DACK3 becomes PWR7, DACK1 becomes PRW6, and DACK0 becomes PWR5.
4-2	R/W	0	These 3 bits select the function for the multiplexed pin K28. Bits Function 4 3 2 XX0 power control 4 (default) 0 1 1 /SMEMR 1 0 1 /PCS2 other Reserved
1	R/W	0	When set to one PWR3 output pin becomes SYSCLK.
0	R/W	0	These 2 bits select the function for the multiplexed pin K29. Bits Function 4 0 X0 PWR2 (default) 0 1 /SMEMW 1 1 /PCS3 other Reserved

4.6.2 VRAM Range Registers (8h, 9h)

Register 8h

Bit	R/W	Default	Function
7	R/W	0	This bit selects A24 as VRAM range.
6	R/W	0	This bit selects A23 as VRAM range.
5	R/W	0	This bit selects A22 as VRAM range.
4	R/W	0	This bit selects A21 as VRAM range.
3	R/W	0	This bit selects A20 as VRAM range.
2	R/W	0	This bit selects A19 as VRAM range.
1	R/W	0	This bit selects A18 as VRAM range.
0	R/W	0	This bit selects A17 as VRAM range.

Register 9h

Bit	R/W	Default	Function
7	R	X	Reserved.
6	R/W	0	This bit selects A31 as VRAM range.
5	R/W	0	This bit selects A30 as VRAM range.
4	R/W	0	This bit selects A29 as VRAM range.
3	R/W	0	This bit selects A28 as VRAM range.
2	R/W	0	This bit selects A27 as VRAM range.
1	R/W	0	This bit selects A26 as VRAM range.
0	R/W	0	This bit selects A25 as VRAM range.

VRAM Range Control Register Ah

Bit	R/W	Default	Function																																																						
7-4	R	X	Reserved.																																																						
3-0	R/W	0	VRAM size select. <table border="1"> <thead> <tr> <th>Bit</th> <th>Addr. Compared</th> <th>VRAM Size</th> </tr> </thead> <tbody> <tr> <td>3210</td> <td></td> <td></td> </tr> <tr> <td>0000</td> <td>Disable VRAM range</td> <td></td> </tr> <tr> <td>0001</td> <td>A17-A31</td> <td>128K</td> </tr> <tr> <td>0010</td> <td>A18-A31</td> <td>256K</td> </tr> <tr> <td>0011</td> <td>A19-A31</td> <td>512K</td> </tr> <tr> <td>0100</td> <td>A20-A31</td> <td>1M</td> </tr> <tr> <td>0101</td> <td>A21-A31</td> <td>2M</td> </tr> <tr> <td>0110</td> <td>A22-A31</td> <td>4M</td> </tr> <tr> <td>0111</td> <td>A23-A31</td> <td>8M</td> </tr> <tr> <td>1000</td> <td>A24-A31</td> <td>16M</td> </tr> <tr> <td>1001</td> <td>A25-A31</td> <td>32M</td> </tr> <tr> <td>1010</td> <td>A26-A31</td> <td>64M</td> </tr> <tr> <td>1011</td> <td>A27-A31</td> <td>128M</td> </tr> <tr> <td>1100</td> <td>A28-A31</td> <td>256M</td> </tr> <tr> <td>1101</td> <td>A29-A31</td> <td>512M</td> </tr> <tr> <td>1110</td> <td>A30-A31</td> <td>1G</td> </tr> <tr> <td>1111</td> <td>A31</td> <td>2G</td> </tr> </tbody> </table>	Bit	Addr. Compared	VRAM Size	3210			0000	Disable VRAM range		0001	A17-A31	128K	0010	A18-A31	256K	0011	A19-A31	512K	0100	A20-A31	1M	0101	A21-A31	2M	0110	A22-A31	4M	0111	A23-A31	8M	1000	A24-A31	16M	1001	A25-A31	32M	1010	A26-A31	64M	1011	A27-A31	128M	1100	A28-A31	256M	1101	A29-A31	512M	1110	A30-A31	1G	1111	A31	2G
Bit	Addr. Compared	VRAM Size																																																							
3210																																																									
0000	Disable VRAM range																																																								
0001	A17-A31	128K																																																							
0010	A18-A31	256K																																																							
0011	A19-A31	512K																																																							
0100	A20-A31	1M																																																							
0101	A21-A31	2M																																																							
0110	A22-A31	4M																																																							
0111	A23-A31	8M																																																							
1000	A24-A31	16M																																																							
1001	A25-A31	32M																																																							
1010	A26-A31	64M																																																							
1011	A27-A31	128M																																																							
1100	A28-A31	256M																																																							
1101	A29-A31	512M																																																							
1110	A30-A31	1G																																																							
1111	A31	2G																																																							

PWRC0 Register 0Bh

Bit	R/W	Default	Function
7	R/W	1	When set to one this bit enables the power control bit 7.
6	R/W	1	When set to one this bit enables the power control bit 6.
5	R/W	1	When set to one this bit enables the power control bit 5.
4	R/W	1	When set to one this bit enables the power control bit 4.
3	R/W	1	When set to one this bit enables the power control bit 3.
2	R/W	1	When set to one this bit enables the power control bit 2.
1	R/W	1	When set to one this bit enables the power control bit 1.
0	R/W	1	When set to one this bit enables the power control bit 0.

PWRC1 Register 0Ch

Bit	R/W	Default	Function
7	R/W	1	When set to one this bit enables power control bit 15.
6	R/W	1	When set to one this bit enables power control bit 14.
5	R/W	1	When set to one this bit enables power control bit 13.
4	R/W	1	When set to one this bit enables power control bit 12.
3	R/W	1	When set to one this bit enables power control bit 11.
2	R/W	1	When set to one this bit enables power control bit 10.
1	R/W	1	When set to one this bit enables power control bit 9.
0	R/W	1	When set to one this bit enables power control bit 8.

Note: Power Control external latch required along with the latch control signal to provide up to eight power control signals.

Scratch Registers Eh, Fh.

The ACC Micro 2051nt contains two 8-bits scratch registers which can be used for any software purposes (for example, it can be used to save some flags in these registers instead of the RTC or system RAM).

4.6.3 Doze Mode

Three timers are used to monitor the activities of IRQ0 and IRQ8, VRAM access, and system events in doze mode. When these timers expired, /STPCLK will be generated to put the CPU in stop grant state.

Doze Mode Control 0 Register 10h

Bit	R/W	Default	Function
7	R/W	0	When set to one this bit increases the time-out period of VRAM doze timer by a factor of 64..
6	R/W	0	When set to one this bit enables DOZE mode state machine.
5*	R/W	0	When this bit is set to one IRQ8 will not affect the timers set by bit [3:1].
4*	R/W	0	When this bit is set to one IRQ0 will not affect the timers set by bit [3:1].
3-1	R/W	0	Time-out period selection for IRQ0/8 doze timer. Bits Time-out Period 3 2 1 0 0 0 Do not use (Doze timer will never expire). 0 0 1 1ms 0 1 0 2ms 0 1 1 3ms 1 0 0 4ms 1 0 1 5ms 1 1 0 6ms 1 1 1 7ms
0	R	0	Reserved.

Note:* When both IRQ8 and IRQ0 are disabled (bit [5:4] equal 1) the system will, depending on the system event or VRAM doze timer (register 11h bit [6:4] and bit 2:0]), enter the doze mode.

Doze Mode Control 1 Register 11h

Bit	R/W	Default	Function
7	R/W	0	When this bit is set to 1, the VRAM doze timer will be by-passed. The system depends on the register 10h bit [3:1] and register 11h bit [2:0] to enter the doze mode.
6-4	R/W	0	Timeout period selection for VRAM doze timer. Bits 6 5 4 0 0 0 Do not use (Doze timer will never expire). 0 0 1 1ms 0 1 0 2ms 0 1 1 3ms 1 0 0 4 ms 1 0 1 5 ms 1 1 0 6 ms 1 1 1 7 ms
3	R/W	0	When this bit is set to 1, the System Event doze timer will be by-passed. The system depends on the register 10h bit [3:1] and register 11h bit [6:4] to enter the doze mode
2-0	R/W	0	Timeout period selection for the SYSTEM EVENT doze timer. Bits 2 1 0 0 0 0 Do not use (Doze timer will never expire) 0 0 1 1/32 sec. 0 1 0 2/32 sec. 0 1 1 3/32 sec. 1 0 0 4/32 sec. 1 0 1 5/32 sec. 1 1 0 6/32 sec. 1 1 1 7/32 sec.

Register 12h

Bit	R/W	Default	Function
7-2	R	0	Reserved.
1	R/W	0	When set to one this bit increases the timeout period of the system event Doze timer by a factor of 8.
0	R/W	0	When set to one this bit increases the timeout period of the IRQ 0/8 Doze timer by a factor of 8.

Doze Mode System Event Timer Trigger Source (Registers 13h-16h)

If there is an activity on any selected trigger source, the Doze Mode System Event timer will be reset and re-counted again.

DMS Source 0 Register 13h

Bit	R/W	Default	Function
7	R/W	0	When this bit is set to 1 IRQ10 will be selected as a trigger source.
6	R/W	0	When this bit is set to 1 IRQ9 will be selected as a trigger source.
5	R/W	0	When this bit is set to 1 IRQ7 will be selected as a trigger source.
4	R/W	0	When this bit is set to 1 IRQ6 will be selected as a trigger source.
3	R/W	0	When this bit is set to 1 IRQ5 will be selected as a trigger source.
2	R/W	0	When this bit is set to 1 IRQ4 will be selected as a trigger source.
1	R/W	0	When this bit is set to 1 IRQ3 will be selected as a trigger source.
0	R/W	0	When this bit is set to 1 IRQ1 will be selected as a trigger source.

DMS Source 1 Register 14h

Bit	R/W	Default	Function
7	R	0	Reserved.
6	R/W	0	When this bit is set to 1 EXTSYS input pin will be selected as a trigger source.
5	R/W	0	When this bit is set to 1 the PCI requested will be selected as a trigger source.
4	R/W	0	When this bit is set to 1 IRQ15 will be selected as a trigger source.
3	R/W	0	When this bit is set to 1 IRQ14 will be selected as a trigger source.
2	R/W	0	When this bit is set to 1 IRQ13 will be selected as a trigger source.
1	R/W	0	When this bit is set to 1 IRQ12 will be selected as a trigger source.
0	R/W	0	When this bit is set to 1 IRQ11 will be selected as a trigger source.

DMS Source 2 Register 15h

Bit	R/W	Default	Function
7	R/W	0	When this bit is set to 1 I/O address 278 will be selected as a trigger source.
6	R/W	0	When this bit is set to 1 I/O address 240 will be selected as a trigger source.
5	R/W	0	When this bit is set to 1 I/O address 220 will be selected as a trigger source.
4	R/W	0	When this bit is set to 1 the hard disk access will be selected as a trigger source.
3	R/W	0	When this bit is set to 1 GCS3 will be selected as a trigger source.
2	R/W	0	When this bit is set to 1 GCS2 will be selected as a trigger source.
1	R/W	0	When this bit is set to 1 GCS1 will be selected as a trigger source.
0	R/W	0	When this bit is set to 1 GCS0 will be selected as a trigger source.

DMS Source 3 Register 16h

Bit	R/W	Default	Function
7	R/W	0	When this bit is set to 1 I/O address 3F8 will be selected as a trigger source.
6	R/W	0	When this bit is set to 1 I/O address 3E8 will be selected as a trigger source.
5	R/W	0	When this bit is set to 1 I/O address 3BC will be selected as a trigger source.
4	R/W	0	When this bit is set to 1 I/O address 388 will be selected as a trigger source.
3	R/W	0	When this bit is set to 1 I/O address 378 will be selected as a trigger source.
2	R/W	0	When this bit is set to 1 I/O address 300 will be selected as a trigger source.
1	R/W	0	When this bit is set to 1 I/O address 2F8 will be selected as a trigger source.
0	R/W	0	When this bit is set to 1 I/O address 2E8 will be selected as a trigger source.

4.6.4 Warning Timer Count Register 18h

Bit	R/W	Default	Function
7-4	R	0	Reserved.
3-0	R/W	0	<p>Timeout period select for the warning timer. Default is 0.</p> <p>Bits</p> <p>3 2 1 0</p> <p>0 0 0 0 Do not use (the warning timer will never expire)</p> <p>0 0 0 1 30 ms</p> <p>0 0 1 0 60 ms</p> <p>0 0 1 1 90 ms</p> <p>0 1 0 0 120 ms</p> <p>0 1 0 1 150 ms</p> <p>0 1 1 0 180 ms</p> <p>0 1 1 1 210 ms</p> <p>1 0 0 0 240 ms</p> <p>1 0 0 1 270 ms</p> <p>1 0 1 0 300 ms</p> <p>1 0 1 1 330 ms</p> <p>1 1 0 0 360 ms</p> <p>1 1 0 1 390 ms</p> <p>1 1 1 0 420 ms</p> <p>1 1 1 1 450 ms</p>

Warning Timer Bypass Register 19h

Bit	R/W	Default	Function
7	R/W	0	When this bit is set to one ACC Micro 2051nt will generate the /SMI due to the active state of ACPWR pin right away instead of waiting for the warning timer to expire before it can generate the /SMI.
6	R/W	0	When this bit is set to one ACC Micro 2051nt will generate the /SMI upon the emulate temperature reached the high/low limit (defined in reg. 50h-53h) right away instead of waiting for the warning timer to expire before it can generate the /SMI.
5	R/W	0	When this bit is set to one ACC Micro 2051nt will generate the /SMI due to the active state of software SMI right away instead of waiting for the warning timer to expire before it can generate the /SMI.
4	R/W	0	When this bit is set to one ACC Micro 2051nt will generate the /SMI due to the active state of EXTSMI2 pin right away instead of waiting for the warning timer to expire before it can generate the /SMI.
3	R/W	0	When this bit is set to one ACC Micro 2051nt will generate the /SMI due to the active state of EXTSMI1 pin right away instead of waiting for the warning timer to expire before it can generate the /SMI.
2	R/W	0	When this bit is set to one ACC Micro 2051nt will generate the /SMI due to the active state of EXTSMI0 pin right away instead of waiting for the warning timer to expire before it can generate the /SMI.
1	R	0	When this bit is set to one ACC Micro 2051nt will generate the /SMI upon the /BATLOW0 timer expired right away instead of waiting for the warning timer to expire before it can generate the /SMI.
0	R	0	When this bit is set to one ACC Micro 2051nt will generate the /SMI due to the active state of /SRBNT pin right away instead of waiting for the warning timer to expire before it can generate the /SMI.

Warning Trigger Bypass**WT Register 1Ah**

Bit	R/W	Default	Function
7-1	R	0	Reserved.
0	R/W	0	When this bit is set to one ACC Micro 2051nt will generate the /SMI upon the general purpose timer expired right away instead of waiting for the warning timer to expire before it can generate the /SMI.

Warning Timer Trigger Source (Registers 1Bh-1Eh)

If there is any activity on any selected trigger source, the warning timer will reset and re-count again.

WTT Source 0 Register 1Bh

Bit	R/W	Default	Function
7	R/W	0	When this bit is set to 1 IRQ10 will be selected as a trigger source.
6	R/W	0	When this bit is set to 1 IRQ9 will be selected as a trigger source.
5	R/W	0	When this bit is set to 1 IRQ7 will be selected as a trigger source.
4	R/W	0	When this bit is set to 1 IRQ6 will be selected as a trigger source.
3	R/W	0	When this bit is set to 1 IRQ5 will be selected as a trigger source.
2	R/W	0	When this bit is set to 1 IRQ4 will be selected as a trigger source.
1	R/W	0	When this bit is set to 1 IRQ3 will be selected as a trigger source.
0	R/W	0	When this bit is set to 1 IRQ1 will be selected as a trigger source.

WTT Source 1 Register 1Ch

Bit	R/W	Default	Function
7	R	0	Reserved.
6	R/W	0	When this bit is set to 1 EXTSYS input pin will be selected as a trigger source.
5	R/W	0	When this bit is set to 1 the PCI requests will be selected as a trigger source.
4	R/W	0	When this bit is set to 1 IRQ15 will be selected as a trigger source.
3	R/W	0	When this bit is set to 1 IRQ14 will be selected as a trigger source.
2	R/W	0	When this bit is set to 1 IRQ13 will be selected as a trigger source.
1	R/W	0	When this bit is set to 1 IRQ12 will be selected as a trigger source.
0	R/W	0	When this bit is set to 1 IRQ11 will be selected as a trigger source.

WTT Source 2 Register 1Dh

Bit	R/W	Default	Function
7	R/W	0	When this bit is set to 1 I/O address 278 will be selected as a trigger source.
6	R/W	0	When this bit is set to 1 I/O address 240 will be selected as a trigger source.
5	R/W	0	When this bit is set to 1 I/O address 220 will be selected as a trigger source.
4	R/W	0	When this bit is set to 1 the hard disk access will be selected as a trigger source.
3	R/W	0	When this bit is set to 1 GCS3 will be selected as a trigger source.
2	R/W	0	When this bit is set to 1 GCS2 will be selected as a trigger source.
1	R/W	0	When this bit is set to 1 GCS1 will be selected as a trigger source.
0	R/W	0	When this bit is set to 1 GCS0 will be selected as a trigger source.

WTT Source 3 Register 1Eh

Bit	R/W	Default	Function
7	R/W	0	When this bit is set to 1 I/O address 3F8 will be selected as a trigger source.
6	R/W	0	When this bit is set to 1 I/O address 3E8 will be selected as a trigger source.
5	R/W	0	When this bit is set to 1 I/O address 3BC will be selected as a trigger source.
4	R/W	0	When this bit is set to 1 I/O address 388 will be selected as a trigger source.
3	R/W	0	When this bit is set to 1 I/O address 378 will be selected as a trigger source.
2	R/W	0	When this bit is set to 1 I/O address 300 will be selected as a trigger source.
1	R/W	0	When this bit is set to 1 I/O address 2F8 will be selected as a trigger source.
0	R/W	0	When this bit is set to 1 I/O address 2E8 will be selected as a trigger source.

4.6.5 General Chip Select (Registers 20h-29h)**GCS Local Standby Control Register 20h**

Bit	R/W	Default	Function
7-4	R	0	Reserved.
3	R/W	0	When set to 1 an active state on programmable GCS1 will cause an SMI to occur. An SMI will not occur if this bit is set to 0.
2	R/W	0	When set to 1 an active state on programmable GCS0 will cause an SMI to occur. An SMI will not occur if this bit is set to 0.
1	R/W	0	Set to 1 to active the GCS1 state machine. When this bit is 0, the GCS1 function will be disabled.
0	R/W	0	Set to 1 to active the GCS0 state machine. When this bit is 0 the GCS0 function will be disable.

GCS0 Low Byte Address Register 21h

Bit	R/W	Default	Function
7	R/W	0	When set to one this bit enables SA7.
6	R/W	0	When set to one this bit enables SA6.
5	R/W	0	When set to one this bit enables SA5.
4	R/W	0	When set to one this bit enables SA4.
3	R/W	0	When set to one this bit enables SA3.
2	R/W	0	When set to one this bit enables SA2.
1	R/W	0	When set to one this bit enables SA1.
0	R/W	0	When set to one this bit enables SA0.

GCS0 High Byte Address Register 22h

Bit	R/W	Default	Function
7	R/W	0	When set to one this bit enables I/O read.
6	R/W	0	When set to one this bit enables I/O write.
5	R/W	0	When set to one this bit masks SA3.
4	R/W	0	When set to one this bit masks SA2.
3	R/W	0	When set to one this bit masks SA1.
2	R/W	0	When set to one this bit masks SA0.
1	R/W	0	When set to one this bit enables SA9.
0	R/W	0	When set to one this bit enables SA8.

GCS1 Low Byte Address Register 23h

Bit	R/W	Default	Function
7	R/W	0	When set to one this bit enables SA7.
6	R/W	0	When set to one this bit enables SA6.
5	R/W	0	When set to one this bit enables SA5.
4	R/W	0	When set to one this bit enables SA4.
3	R/W	0	When set to one this bit enables SA3.
2	R/W	0	When set to one this bit enables SA2.
1	R/W	0	When set to one this bit enables SA1.
0	R/W	0	When set to one this bit enables SA0.

GCS1 High Byte Address Register 24h

Bit	R/W	Default	Function
7	R/W	0	When set to one this bit enables I/O read.
6	R/W	0	When set to one this bit enables I/O write.
5	R/W	0	When set to one this bit masks SA3.
4	R/W	0	When set to one this bit masks SA2.
3	R/W	0	When set to one this bit masks SA1.
2	R/W	0	When set to one this bit masks SA0.
1	R/W	0	When set to one this bit enables SA9.
0	R/W	0	When set to one this bit enables SA8.

GCS2 Low Byte Address Register 25h

Bit	R/W	Default	Function
7	R/W	0	When set to one this bit enables SA7.
6	R/W	0	When set to one this bit enables SA6.
5	R/W	0	When set to one this bit enables SA5.
4	R/W	0	When set to one this bit enables SA4.
3	R/W	0	When set to one this bit enables SA3.
2	R/W	0	When set to one this bit enables SA2.
1	R/W	0	When set to one this bit enables SA1.
0	R/W	0	When set to one this bit enables SA0.

GCS2 High Byte Address Register 26h

Bit	R/W	Default	Function
7	R/W	0	When set to one this bit enables I/O read.
6	R/W	0	When set to one this bit enables I/O write.
5	R/W	0	When set to one this bit masks SA3.
4	R/W	0	When set to one this bit masks SA2.
3	R/W	0	When set to one this bit masks SA1.
2	R/W	0	When set to one this bit masks SA0.
1	R/W	0	When set to one this bit enables SA9.
0	R/W	0	When set to one this bit enables SA8.

GCS3 Low Byte Address Register 27h

Bit	R/W	Default	Function
7	R/W	0	When set to one this bit enables SA7.
6	R/W	0	When set to one this bit enables SA6.
5	R/W	0	When set to one this bit enables SA5.
4	R/W	0	When set to one this bit enables SA4.
3	R/W	0	When set to one this bit enables SA3.
2	R/W	0	When set to one this bit enables SA2.
1	R/W	0	When set to one this bit enables SA1.
0	R/W	0	When set to one this bit enables SA0.

GCS3 High Byte Address Register 28h

Bit	R/W	Default	Function
7	R/W	0	When set to one this bit enables I/O read.
6	R/W	0	When set to one this bit enables I/O write.
5	R/W	0	When set to one this bit masks SA3.
4	R/W	0	When set to one this bit masks SA2.
3	R/W	0	When set to one this bit masks SA1.
2	R/W	0	When set to one this bit masks SA0.
1	R/W	0	When set to one this bit enables SA9.
0	R/W	0	When set to one this bit enables SA8.

General Chip Select

GCS0 and GCS1 Count Register 29h

Bit	R/W	Default	Function
7-4	R/W	0	Timeout period selection for GCS1 local standby idle timer Bits 7 6 5 4 0 0 0 0 Do not use (GCS1 timer will never expire) 0 0 0 1 1 min 0 0 1 0 2 min 0 0 1 1 3 min 0 1 0 0 4 min 0 1 0 1 5 min 0 1 1 0 6 min 0 1 1 1 7 min 1 0 0 0 8 min 1 0 0 1 9 min 1 0 1 0 10 min 1 0 1 1 11 min 1 1 0 0 12 min 1 1 0 1 13 min 1 1 1 0 14 min 1 1 1 1 15 min
3-0	R/W	0	Timeout period selection for GCS0 local standby idle timer Bits 3 2 1 0 0 0 0 0 Do not use (GCS0 timer will never expire) 0 0 0 1 1 min 0 0 1 0 2 min 0 0 1 1 3 min 0 1 0 0 4 min 0 1 0 1 5 min 0 1 1 0 6 min 0 1 1 1 7 min 1 0 0 0 8 min 1 0 0 1 9 min 1 0 1 0 10 min 1 0 1 1 11 min 1 1 0 0 12 min 1 1 0 1 13 min 1 1 1 0 14 min 1 1 1 1 15 min

GCS2 and GCS3 Count Register 2Ah

Bit	R/W	Default	Function
7-4	R/W	0	Timeout period selection for GCS3 local standby idle timer Bits 7 6 5 4 0 0 0 0 Disable 0 0 0 1 1 min 0 0 1 0 2 min 0 0 1 1 3 min 0 1 0 0 4 min 0 1 0 1 5 min 0 1 1 0 6 min 0 1 1 1 7 min 1 0 0 0 8 min 1 0 0 1 9 min 1 0 1 0 10 min 1 0 1 1 11 min 1 1 0 0 12 min 1 1 0 1 13 min 1 1 1 0 14 min 1 1 1 1 15 min
3-0	R/W	0	Timeout period selection for GCS2 local standby idle timer Bits 3 2 1 0 0 0 0 0 Disable 0 0 0 1 1 min 0 0 1 0 2 min 0 0 1 1 3 min 0 1 0 0 4 min 0 1 0 1 5 min 0 1 1 0 6 min 0 1 1 1 7 min 1 0 0 0 8 min 1 0 0 1 9 min 1 0 1 0 10 min 1 0 1 1 11 min 1 1 0 0 12 min 1 1 0 1 13 min 1 1 1 0 14 min 1 1 1 1 15 min

4.6.6 LCD Local Standby Control 0 Register 2Bh

Bit	R/W	Default	Function
7-6	R	0	Reserved
5	R/W	0	When set to one this bit disables VRAM (LCD VRAM idle timer will always be timed out, irrespective of the programmed count).
4	R/W	0	When this bit is set to 1 IRQ12 will be selected as a trigger source for the LCD keyboard idle timer.
3	R/W	0	When this bit is set to 1 IRQ4 will be selected as a trigger source for the LCD keyboard idle timer.
2	R/W	0	When this bit is set to 1 IRQ3 will be selected as a trigger source for the LCD keyboard idle timer.
1	R/W	0	When this bit is set to 1 IRQ1 will be selected as a trigger source of the LCD keyboard idle timer.
0	R/W	0	The LCD local standby state machine is enabled when this bit is set to 1.

LCD Local Standby Control 1 Register 2Ch

Bit	R/W	Default	Function
7-6	R	0	Reserved.
5	R/W	0	When set to one this bit selects VRAM write as an LCD break event.
4	R/W	0	When set to one this bit selects IRQ12 as an LCD break event.
3	R/W	0	When set to one this bit selects IRQ4 as an LCD break event.
2	R/W	0	When set to one this bit selects IRQ3 as an LCD break event.
1	R/W	0	When set to one this bit selects IRQ1 as an LCD break event.
0	R/W	0	When this bit is set to 1 an activity on any selected LCD break event will cause an SMI to exit the LCD local standby to occur. If this bit is 0 /SMI will not assert when a break event occur. Therefore system will always stays in the standby mode.

LCD Keyboard and VRAM Count Register 2Eh

Bit	R/W	Default	Function
7-4	R/W	0	Timeout period selection for LCD keyboard idle timer Bits 7 6 5 4 0 0 0 0 Do not use (LCD keyboard idle timer will never expire) 0 0 0 1 1 min 0 0 1 0 2 min 0 0 1 1 3 min 0 1 0 0 4 min 0 1 0 1 5 min 0 1 1 0 6 min 0 1 1 1 7 min 1 0 0 0 8 min 1 0 0 1 9 min 1 0 1 0 10 min 1 0 1 1 11 min 1 1 0 0 12 min 1 1 0 1 13 min 1 1 1 0 14 min 1 1 1 1 15 min
3--0	R/W	0	Timeout period selection for LCD VRAM idle timer. Bits 3 2 1 0 0 0 0 0 Do not use (LCD VRAM idle timer will never expire) 0 0 0 1 1/8 sec 0 0 1 0 1/4 sec. 0 0 1 1 3/8 sec. 0 1 0 0 1/2 sec. 0 1 0 1 5/8 sec. 0 1 1 0 3/4 sec. 0 1 1 1 7/8 sec. 1 0 0 0 1 sec. 1 0 0 1 8 sec. 1 0 1 0 16 sec. 1 0 1 1 24 sec. 1 1 0 0 32 sec. 1 1 0 1 40 sec. 1 1 1 0 48 sec. 1 1 1 1 56 sec.

Global Standby Control Register 30h

Bit	R/W	Default	Function
7-3	R	0	Reserved
2	R/W	0	When this bit is set to 1 the VRAM write will be selected as a break event.
1	R/W	0	When this bit is set to 1 the global standby VRAM timer will be by-passed. The system will depend on the global standby system event timer to enter the global standby mode. When this bit is 0 the system will enter the standby mode when both the VRAM and system event timers expired.
0	R/W	0	When this bit is set to 1 a transition on any selected global standby break event will cause an SMI to occur. If this bit is 0 /SMI will not assert when a break event occur.

Global Standby System Event and VRAM Count Register 31h

Bit	R/W	Default	Function
7-4	R/W	0	Timeout period selection for Global Standby system event idle timer Bits 7 6 5 4 0 0 0 0 Do not use (system event timer will never expire) 0 0 0 1 1 min 0 0 1 0 2 min 0 0 1 1 3 min 0 1 0 0 4 min 0 1 0 1 5 min 0 1 1 0 6 min 0 1 1 1 7 min 1 0 0 0 8 min 1 0 0 1 9 min 1 0 1 0 10 min 1 0 1 1 11 min 1 1 0 0 12 min 1 1 0 1 13 min 1 1 1 0 14 min 1 1 1 1 15 min
3-0	R/W	0	Timeout period selection for Global Standby VRAM idle timer. Bits 3 2 1 0 0 0 0 0 Do not use (VRAM timer will never expire) 0 0 0 1 1/8 sec 0 0 1 0 1/4 sec. 0 0 1 1 3/8 sec. 0 1 0 0 1/2 sec. 0 1 0 1 5/8 sec. 0 1 1 0 3/4 sec. 0 1 1 1 7/8 sec. 1 0 0 0 1 sec. 1 0 0 1 8 sec. 1 0 1 0 16 sec. 1 0 1 1 24 sec. 1 1 0 0 32 sec. 1 1 0 1 40 sec. 1 1 1 0 48 sec. 1 1 1 1 56 sec.

Global Standby System Event Timer Trigger Source (Register 32h-35h)

If there is an activity on any selected trigger source, the global standby system event timer will reset and re-count again.

GSS Source 0 Register 32h

Bit	R/W	Default	Function
7	R/W	0	When set to one IRQ10 will be selected as a trigger source for the G.S. system event timer.
6	R/W	0	When set to one IRQ9 will be selected as a trigger source for the G.S. system event timer.
5	R/W	0	When set to one IRQ7 will be selected as a trigger source for the G.S. system event timer.
4	R/W	0	When set to one IRQ6 will be selected as a trigger source for the G.S. system event timer.
3	R/W	0	When set to one IRQ5 will be selected as a trigger source for the G.S. system event timer.
2	R/W	0	When set to one IRQ4 will be selected as a trigger source for the G.S. system event timer.
1	R/W	0	When set to one IRQ3 will be selected as a trigger source for the G.S. system event timer.
0	R/W	0	When set to one IRQ1 will be selected as a trigger source for the G.S. system event timer.

GSS Source 1 Register 33h

Bit	R/W	Default	Function
7	R	0	Reserved.
6	R/W	0	When set to one EXTSYS input pin will be selected as a trigger source for the G.S. system event timer.
5	R/W	0	When set to one the PCI request will be selected as a trigger source for the G.S. system event timer.
4	R/W	0	When set to one IRQ15 will be selected as a trigger source for the G.S. system event timer.
3	R/W	0	When set to one IRQ14 will be selected as a trigger source for the G.S. system event timer.
2	R/W	0	When set to one IRQ13 will be selected as a trigger source for the G.S. system event timer.
1	R/W	0	When set to one IRQ12 will be selected as a trigger source for the G.S. system event timer.
0	R/W	0	When set to one IRQ11 will be selected as a trigger source for the G.S. system event timer.

Global Standby System Event Timer Trigger Source**GSS Source 2 Register 34h**

Bit	R/W	Default	Function
7	R/W	0	When set to one the base address 278h will be selected as a trigger source for G.S. system event timer.
6	R/W	0	When set to one the base address 240h will be selected as a trigger source for G.S. system event timer.
5	R/W	0	When set to one the base address 220h will be selected as a trigger source for G.S. system event timer.
4	R/W	0	When set to one the HDD (base address 1F0h & 170h) will be selected as a trigger source for G.S. system event timer.
3	R/W	0	When set to one the GCS3 will be selected as a trigger source for G.S. system event timer.
2	R/W	0	When set to one the GCS2 will be selected as a trigger source for G.S. system event timer.
1	R/W	0	When set to one the GCS1 will be selected as a trigger source for G.S. system event timer.
0	R/W	0	When set to one the GCS0 will be selected as a trigger source for G.S. system event timer.

Global Standby System Event Timer Trigger Source**GSS Source 3 Register 35h**

Bit	R/W	Default	Function
7	R/W	0	When set to one base address 3F8h will be selected as a trigger source for G.S. system event timer.
6	R/W	0	When set to one base address 3E8h will be selected as a trigger source for G.S. system event timer.
5	R/W	0	When set to one base address 3BCh will be selected as a trigger source for G.S. system event timer.
4	R/W	0	When set to one base address 388 will be selected as a trigger source for G.S. system event timer.
3	R/W	0	When set to one base address 378 will be selected as a trigger source for G.S. system event timer.
2	R/W	0	When set to one base address 300 will be selected as a trigger source for G.S. system event timer.
1	R/W	0	When set to one base address 2F8 will be selected as a trigger source for G.S. system event timer.
0	R/W	0	When set to one base address 2E8 will be selected as a trigger source for G.S. system event timer.

Global Standby Break Event (Registers 37h-3Ah)

GS Break 0 Register 37h

Bit	R/W	Default	Function
7	R/W	0	When set to one IRQ10 will be selected as a G.S. break event .
6	R/W	0	When set to one IRQ9 will be selected as a G.S. break event .
5	R/W	0	When set to one IRQ7 will be selected as a G.S. break event .
4	R/W	0	When set to one IRQ6 will be selected as a G.S. break event.
3	R/W	0	When set to one IRQ5 will be selected as a G.S. break event .
2	R/W	0	When set to one IRQ4 will be selected as a G.S. break event .
1	R/W	0	When set to one IRQ3 will be selected as a G.S. break event .
0	R/W	0	When set to one IRQ1 is selected as a G.S. break event .

GS Break 1 Register 38h

Bit	R/W	Default	Function
7	R	0	Reserved.
6	R/W	0	When set to one the EXTSYS will be selected as a G.S. break event.
5	R/W	0	When set to one the PCI request will be selected as a G.S. break event.
4	R/W	0	When set to one the IRQ15 will be selected as a G.S. break event.
3	R/W	0	When set to one the IRQ14 will be selected as a G.S. break event.
2	R/W	0	When set to one the IRQ13 will be selected as a G.S. break event.
1	R/W	0	When set to one the IRQ12 will be selected as a G.S. break event.
0	R/W	0	When set to one the IRQ11 will be selected as a G.S. break event.

GS Break 2 Register 39h

Bit	R/W	Default	Function
7	R/W	0	When set to one the base address 278h will be selected as a G.S. break event.
6	R/W	0	When set to one the base address 240h will be selected as a the G.S. break event.
5	R/W	0	When set to one the base address 220h will be selected as a G.S. break event.
4	R/W	0	When set to one the HDD (base address 1F0h & 170h) will be selected as a G.S. break event.
3	R/W	0	When set to one the base address GCS3 will be selected as a G.S. break event .
2	R/W	0	When set to one the base address GCS2 will be selected as a G.S. break event .
1	R/W	0	When set to one the base address GCS1 will be selected as a G.S. break event.
0	R/W	0	When set to one the base address GCS0 will be selected as a G.S. break event.

Global Standby Break Event

GS Break 3 Register 3Ah

Bit	R/W	Default	Function
7	R/W	0	When set to one the base address 3F8h will be selected as a G.S. break event.
6	R/W	0	When set to one the base address 3E8h will be selected as a G.S. break event.
5	R/W	0	When set to one the base address 3BCh will be selected as a G.S. break event.
4	R/W	0	When set to one the base address 388 will be selected as a G.S. break event.
3	R/W	0	When set to one the base address 378 will be selected as a G.S. break event.
2	R/W	0	When set to one the base address 300 will be selected as a G.S. break event.
1	R/W	0	When set to one the base address 2F8 will be selected as a G.S. break event.
0	R/W	0	When set to one the base address 2E8 will be selected as a G.S. break event.

External SMI Control**External SMI Control Register 3Ch**

Bit	R/W	Default	Function
7	R	0	Reserved.
6	R/W	0	Set to one to select EXTSMI2 input pin as the falling edge trigger. The EXTSMI2 input pin is defaulted as the rising edge trigger.
5	R/W	0	Set to one to select EXTSMI1 input pin as the falling edge trigger. The EXTSMI1 input pin is defaulted as the rising edge trigger.
4	R/W	0	Set to one to select EXTSMI0 input pin as the falling edge trigger. The EXTSMI0 input pin is defaulted the rising edge trigger.
3	R	0	Reserved.
2	R/W	0	Set this bit to 1 to enable the EXTSMI2 mode. And if reg. 0h bit 3 is set to 1 an active state on this input pin will cause an SMI to occur.
1	R/W	0	Set this bit to 1 to enable the EXTSMI1 mode. And if reg. 0h bit 3 is set to 1 an active state on this input pin will cause an SMI to occur.
0	R/W	0	Set this bit to 1 to enable the EXTSMI0 mode. And if reg. 0h bit 3 is set to 1 an active state on this input pin will cause an SMI to occur.

Software SMI Control**Software SMI Control Register 3Eh**

Bit	R/W	Default	Function
7-1	R	0	Reserved.
0	R/W	0	If register 0h bit 4 is set to 1 then when there is a transition of 0 to 1 on this bit it will cause an /SMI to occur.

4.6.7 Suspend Control 0 Register 40h

Bit	R/W	Default	Function
7	R/W	0	When set to one the timeout period of the auto suspend VRAM timer increases by a factor of 16.
6	R/W	0	When set to one the timeout period of the auto suspend system event timer increases by a factor of 16.
5	R/W	0	When set to one the VRAM write will be selected as a break event.
4	R/W	0	When this bit is set to 1 the auto suspend VRAM timer will be by-passed. The system will depend on the auto suspend system event timer to enter the auto suspend mode.
3	R/W	0	When this bit is set to 1 a transition on any selected suspend break events will cause an (exit auto suspend) SMI to occur.
2	R/W	0	Set this bit to 1 to enable the /BATLOW0 input function as one of the event to let the system enter the suspend mode.
1	R/W	0	Set this bit to 1 to enable the /SRBTN input function as one of the event to let the system enter the suspend mode.
0	R/W	0	Set this bit to 1 to enable the auto suspend timer function as one of the event to let the system enter the suspend mode.

Suspend Control 1 Register 41h

Bit	R/W	Default	Function
7	R/W	0	When this bit is set to 1, along with suspend control register 80h bit 1, and bit 0 set to 1, the ROM interface will be driven low so that the ROM's power can be turn-off (through the external power transistor logic).
6	R	0	Reserved. Must set to zero.
5	R/W	0	When this bit is set to 1, along with suspend control register 80h bit 3 and bit 0 set to one, the 2051nt will drive the CPU interface low so that the CPU power can be powered-off during suspend mode.
4	R/W	0	When this bit is set to 1, along with suspend control register 80h bit 1 and bit 0 set to one, the 2051nt will drive the ISA interface low so that the ISA power can be powered-off during suspend mode.
3	R/W	0	When this bit is set to 1, along with suspend control register 80h bit 2 and bit 0 set to one, the 2051nt will drive the PCI interface low so that the PCI power can be powered-off during suspend mode.
2	R/W	0	When this bit is set to one the 2051nt will drive out /SUSP output signal during the suspend mode.
1	R/W	0	When this bit is set to one the 0-volt state machine is enabled where it allows all the controls to be saved in the hard disk when the suspend conditions are met either through software or hardware.
0	R/W	0	When Register 80h, bit 0 (page 51) and this bit are set to one the power on suspend is enabled where the clock can be stopped and all devices can be powered-off except the ACC Micro 2051nt and the DRAM.

Suspend Control 2 Register 42h

Bit	R/W	Default	Function
7-5	R	0	Reserved.
4	R/W	0	When set to one the 14.318MHz clock (inside the ACC Micro 2051nt) will be stopped in the suspend mode so that the clock chip can be powered-off.
3	R/W	0	When set to one the SYSCLK will be stopped in the suspend mode.
2	R/W	0	When set to one the PCICLK will be stopped in the suspend mode.
1	R/W	0	When set to one the CLKSRC (inside the ACC Micro 2051nt) will be stopped in the suspend mode so that the clock chip can be powered-off.
0	R/W	0	When set to one the CPU clock will be stopped at 0 Hz in the suspend mode.

Auto Suspend System Event and VRAM Count Register 43h

Bit	R/W	Default	Function
7-4	R/W	0	Timeout period selection for Auto Suspend System Event Idle timer Bits 7 6 5 4 0 0 0 0 Do not use (system event timer will never expire) 0 0 0 1 2 min. 0 0 1 0 4 min. 0 0 1 1 6 min. 0 1 0 0 8 min. 0 1 0 1 10 min. 0 1 1 0 12 min. 0 1 1 1 14 min. 1 0 0 0 16 min. 1 0 0 1 18 min. 1 0 1 0 20 min. 1 0 1 1 22 min. 1 1 0 0 24 min. 1 1 0 1 26 min. 1 1 1 0 28 min. 1 1 1 1 30 min.
3--0	R/W	0	Timeout period selection for Auto Suspend VRAM idle timer. Bits 3 2 1 0 0 0 0 0 Do not use (suspend VRAM timer will never expire) 0 0 0 1 1/8 sec 0 0 1 0 1/4 sec. 0 0 1 1 3/8 sec. 0 1 0 0 1/2 sec. 0 1 0 1 5/8 sec. 0 1 1 0 3/4 sec. 0 1 1 1 7/8 sec. 1 0 0 0 1 sec. 1 0 0 1 8 sec. 1 0 1 0 16 sec. 1 0 1 1 24 sec. 1 1 0 0 32 sec. 1 1 0 1 40 sec. 1 1 1 0 48 sec. 1 1 1 1 56 sec.

4.6.8 Battery Low Control Register 44h

Bit	R/W	Default	Function
7	R/W	0	When set to one 8 KHz will be selected for battery tone.
6	R/W	0	When set to one 4 KHz will be selected for battery tone.
5	R/W	0	When set to one 2 KHz will be selected for battery tone.
4	R/W	0	When set to one 1 KHz will be selected for battery tone.
3	R/W	0	Set to one to disable all trigger sources (defined in reg. 46h-49h) of battery low timer.
2	R/W	0	When set to one no internal speaker output tone will be generated to gate timer 2. when battery is low, so external logic can drive the SPKR.
1	R/W	0	When set to one the warning tone will be generated every 8 seconds. Default is 4 seconds.
0	R/W	0	When set to one it enables battery low control.

Battery Low Count Register 45h

Bit	R/W	Default	Function
7-4	R	0	Reserved.
3-0	R/W	0	Timeout period selection for Battery Low timer Bits 3 2 1 0 0 0 0 0 Battery low timer will always be timed-out 0 0 0 1 30 sec. 0 0 1 0 1 min. 0 0 1 1 1.5 min. 0 1 0 0 2 min. 0 1 0 1 2.5 min. 0 1 1 0 3 min. 0 1 1 1 3.5 min. 1 0 0 0 4 min. 1 0 0 1 4.5 min. 1 0 1 0 5 min. 1 0 1 1 5.5 min. 1 1 0 0 6 min. 1 1 0 1 6.5 min. 1 1 1 0 7 min. 1 1 1 1 7.5 min.

Auto Suspend Timer and Battery Low Timer Trigger Source

AST Source 0 Register 46h

Bit	R/W	Default	Function
7	R/W	0	When set to one IRQ10 will be selected as a trigger source.
6	R/W	0	When set to one IRQ9 will be selected as a trigger source.
5	R/W	0	When set to one IRQ7 will be selected as a trigger source.
4	R/W	0	When set to one IRQ6 will be selected as a trigger source.
3	R/W	0	When set to one IRQ5 will be selected as a trigger source.
2	R/W	0	When set to one IRQ4 will be selected as a trigger source.
1	R/W	0	When set to one IRQ3 will be selected as a trigger source.
0	R/W	0	When set to one IRQ1 will be selected as a trigger source.

AST Source 1 Register 47h

Bit	R/W	Default	Function
7	R	0	Reserved.
6	R/W	0	When set to one the EXTSYS input pin will be selected as a trigger source.
5	R/W	0	When set to one the PCI request will be selected as a trigger source.
4	R/W	0	When set to one the IRQ15 will be selected as a trigger source.
3	R/W	0	When set to one the IRQ14 will be selected as a trigger source.
2	R/W	0	When set to one the IRQ13 will be selected as a trigger source.
1	R/W	0	When set to one the IRQ12 will be selected as a trigger source.
0	R/W	0	When set to one the IRQ11 will be selected as a trigger source.

AST Source 2 Register 48h

Bit	R/W	Default	Function
7	R/W	0	When set to one the base address 278h will be selected as a trigger source.
6	R/W	0	When set to one the base address 240h will be selected as a trigger source.
5	R/W	0	When set to one the base address 220h will be selected as a trigger source.
4	R/W	0	When set to one the HDD (base address 1F0h & 170h) will be selected as a trigger source.
3	R/W	0	When set to one the GCS3 will be selected as a trigger source.
2	R/W	0	When set to one the GCS2 will be selected as a trigger source.
1	R/W	0	When set to one the GCS1 will be selected as a trigger source.
0	R/W	0	When set to one the GCS0 will be selected as a trigger source.

AST Source 3 Register 49h

Bit	R/W	Default	Function
7	R/W	0	When set to one the base address 3F8h will be selected as a trigger source.
6	R/W	0	When set to one the base address 3E8h will be selected as a trigger source.
5	R/W	0	When set to one the base address 3BCh will be selected as a trigger source.
4	R/W	0	When set to one the base address 388h will be selected as a trigger source.
3	R/W	0	When set to one the base address 378h will be selected as a trigger source.
2	R/W	0	When set to one the base address 300h will be selected as a trigger source.
1	R/W	0	When set to one the base address 2F8h will be selected as a trigger source.
0	R/W	0	When set to one the base address 2E8h will be selected as a trigger source.

Auto Suspend Break Event

ASBE0 Register 4Bh

Bit	R/W	Default	Function
7	R/W	0	When set to one IRQ10 will be selected as a auto suspend break event.
6	R/W	0	When set to one IRQ9 will be selected as a auto suspend break event.
5	R/W	0	When set to one IRQ7 will be selected as a auto suspend break event.
4	R/W	0	When set to one IRQ6 will be selected as a auto suspend break event.
3	R/W	0	When set to one IRQ5 will be selected as a auto suspend break event.
2	R/W	0	When set to one IRQ4 will be selected as a auto suspend break event.
1	R/W	0	When set to one IRQ3 will be selected as a auto suspend break event.
0	R/W	0	When set to one IRQ1 will be selected as a auto suspend break event.

ASBE1 Register 4Ch

Bit	R/W	Default	Function
7	R	0	Reserved.
6	R/W	0	When set to one the EXTSYS input pin will be selected as a auto suspend break event.
5	R/W	0	When set to one the PCI request will be selected as a auto suspend break event.
4	R/W	0	When set to one IRQ15 will be selected as a auto suspend break event.
3	R/W	0	When set to one IRQ will be is selected as a auto suspend break event.
2	R/W	0	When set to one IRQ13 will be selected as a auto suspend break event.
1	R/W	0	When set to one IRQ12 will be selected as a auto suspend break event.
0	R/W	0	When set to one IRQ11 will be selected as a auto suspend break event.

ASBE2 Register 4Dh

Bit	R/W	Default	Function
7	R/W	0	When set to one the base address 278h will be selected as a auto suspend break event.
6	R/W	0	When set to one the base address 240h will be selected as a auto suspend break event.
5	R/W	0	When set to one the base address 220h will be selected as a auto suspend break event.
4	R/W	0	When set to one the HDD base address (1F0h & 170h) will be selected as a auto suspend break event.
3	R/W	0	When set to one the base address GCS3 will be selected as a auto suspend break event.
2	R/W	0	When set to one the base address GCS2 will be selected as a auto suspend break event.
1	R/W	0	When set to one the base address GCS1 will be selected as a auto suspend break event.
0	R/W	0	When set to one the base address GCS0 will be selected as a auto suspend break event.

ASBE3 Register 4Eh

Bit	R/W	Default	Function
7	R/W	0	When set to one the base address 3F8h will be selected as a auto suspend break event.
6	R/W	0	When set to one the base address 3E8h will be selected as a auto suspend break event.
5	R/W	0	When set to one the base address 3BCh will be selected as a auto suspend break event.
4	R/W	0	When set to one the base address 388h will be selected as a auto suspend break event.
3	R/W	0	When set to one the base address 378h will be selected as a auto suspend break event.
2	R/W	0	When set to one the base address 300h will be selected as a auto suspend break event.
1	R/W	0	When set to one the base address 2F8h will be selected as a auto suspend break event.
0	R/W	0	When set to one the base address 2E8h will be selected as a auto suspend break event.

4.6.9 Thermal Control Through Software Emulation (Registers 50h-53h)

The CPU temperature can be sensed through the software emulation where the upper and lower limit can be set based on the system configuration. When the system reaches the upper or lower limit, /SMI may be generated to enable the throttle mode to reduce the temperature or bring the system up to the normal operating frequency.

Register 50h

Bit	R/W	Default	Function
7	R/W	0	High limit bit 3.
6	R/W	0	High limit bit 2.
5	R/W	0	High limit bit 1.
4	R/W	0	High limit bit 0.
3	R/W	0	Low limit bit 3.
2	R/W	0	Low limit bit 2.
1	R/W	0	Low limit bit 1.
0	R/W	0	Low limit bit 0.

Register 51h

Bit	R/W	Default	Function
7	R/W	0	Low saturate bit 3.
6	R/W	0	Low saturate bit 2.
5	R/W	0	Low saturate bit 1.
4	R/W	0	Low saturate bit 0.
3	R	0	Reserved. Set to zero.
2	R/W	0	Enable temperature SMI.
1	R/W	0	Enable two segment counting.
0	R/W	0	Enable temperature control.

Register 52h

Bit	R/W	Default	Function
7	R	0	Temperature emulation counter bit 9. Read only.
6	R	0	Temperature emulation counter bit 8. Read only.
5	R	0	Temperature emulation counter bit 7. Read only.
4	R	0	Temperature emulation counter bit 6. Read only.
3	R	0	Temperature emulation counter bit 5. Read only.
2	R	0	Temperature emulation counter bit 4. Read only.
1	R	0	Temperature emulation counter bit 3. Read only.
0	R	0	Temperature emulation counter bit 2. Read only.

Register 53h

Bit	R/W	Default	Function
7	R	0	Temperature emulation counter bit 17. Read only.
6	R	0	Temperature emulation counter bit 16. Read only.
5	R	0	Temperature emulation counter bit 15. Read only.
4	R	0	Temperature emulation counter bit 14. Read only.
3	R	0	Temperature emulation counter bit 13. Read only.
2	R	0	Temperature emulation counter bit 12. Read only.
1	R	0	Temperature emulation counter bit 11. Read only.
0	R	0	Temperature emulation counter bit 10. Read only.

4.6.10 STOP CLOCK Control

STPCLK0 Register 54h

Bit	R/W	Default	Function																				
7-5	R/W	0	Stop clock throttle duty cycle select. <table border="0"> <thead> <tr> <th>Bits</th> <th>Duty Cycle</th> </tr> </thead> <tbody> <tr> <td>765</td> <td></td> </tr> <tr> <td>000</td> <td>Disable</td> </tr> <tr> <td>001</td> <td>1/8</td> </tr> <tr> <td>010</td> <td>1/4</td> </tr> <tr> <td>011</td> <td>3/8</td> </tr> <tr> <td>100</td> <td>1/2</td> </tr> <tr> <td>101</td> <td>5/8</td> </tr> <tr> <td>110</td> <td>3/4</td> </tr> <tr> <td>111</td> <td>7/8</td> </tr> </tbody> </table>	Bits	Duty Cycle	765		000	Disable	001	1/8	010	1/4	011	3/8	100	1/2	101	5/8	110	3/4	111	7/8
Bits	Duty Cycle																						
765																							
000	Disable																						
001	1/8																						
010	1/4																						
011	3/8																						
100	1/2																						
101	5/8																						
110	3/4																						
111	7/8																						
4	R/W	0	When there is a transition from 0 to 1 on this bit /STPCLK will be asserted until the INTR signal occurs.																				
3	R/W	0	When set to 1 the throttle mode stop clock will be activated.																				
2	R	0	Reserved.																				
1	R/W	0	When this bit is set to one /STPCLK will be asserted when the temperature meet the high limit defined by Register 50h. The throttle clock and duty cycle which allowed /STPCLK to be asserted are defined in Register 54h-55h.																				
0	R/W	0	Set this bit to 1 to allow /STPCLK to be asserted when the doze timers time-out.																				

STPCLK1 (Throttle Mode Clock Source) Register 55h

Bit	R/W	Default	Function																				
7	R	0	Reserved.																				
6-5	R/W	0	<p>These bits select the time period for the /STPCLK being deasserted after any interrupt acknowledge cycle for throttle mode.</p> <table> <thead> <tr> <th>Bits</th> <th>Time</th> </tr> </thead> <tbody> <tr> <td>65</td> <td></td> </tr> <tr> <td>00</td> <td>64 us</td> </tr> <tr> <td>01</td> <td>1 ms</td> </tr> <tr> <td>10</td> <td>4 ms</td> </tr> <tr> <td>11</td> <td>16ms</td> </tr> </tbody> </table>	Bits	Time	65		00	64 us	01	1 ms	10	4 ms	11	16ms								
Bits	Time																						
65																							
00	64 us																						
01	1 ms																						
10	4 ms																						
11	16ms																						
4	R/W	0	When set to one /STPCLK will be deasserted for a period of time (defined by bit 6-5) after any interrupt acknowledge cycle for throttle mode.																				
3	R	0	Reserved.																				
2-0	R/W	0	<p>Throttle clock select. There are eight throttle clock for every throttle cycle.</p> <table> <thead> <tr> <th>Bits</th> <th>Clock</th> </tr> </thead> <tbody> <tr> <td>210</td> <td></td> </tr> <tr> <td>000</td> <td>1/2 ms</td> </tr> <tr> <td>001</td> <td>2 ms</td> </tr> <tr> <td>010</td> <td>8 ms</td> </tr> <tr> <td>011</td> <td>32 ms</td> </tr> <tr> <td>100</td> <td>256 ms</td> </tr> <tr> <td>101</td> <td>2 s</td> </tr> <tr> <td>110</td> <td>16 s</td> </tr> <tr> <td>111</td> <td>128 s</td> </tr> </tbody> </table>	Bits	Clock	210		000	1/2 ms	001	2 ms	010	8 ms	011	32 ms	100	256 ms	101	2 s	110	16 s	111	128 s
Bits	Clock																						
210																							
000	1/2 ms																						
001	2 ms																						
010	8 ms																						
011	32 ms																						
100	256 ms																						
101	2 s																						
110	16 s																						
111	128 s																						

General Purpose Timer Register 57h

The general purpose timer allows the /SMI to be generated whenever the timer is expired.

Bit	R/W	Default	Function
7-6	R/W	0	When set to (1,1) the device 0, function 0 will be the PCI early address mode.
5	R	0	Reserved.
4	R/W	0	When set to 1, the timeout period of the general purpose timer will increase by a factor of 16.
3-0	R/W	0	Time-out period selection for general timer. Bits 3210 (cycles) 0000 Disable 0001 1 min. 0010 2 min. 0011 3 min. 0100 4 min. 0101 5 min. 0110 6 min. 0111 7 min. 1000 8 min. 1001 9 min. 1010 10 min. 1011 11 min. 1100 12 min. 1101 13 min. 1110 14 min. 1111 15 min.

4.7 Interrupt Controller Registers

The interrupt controller registers can be accessed by writing to I/O address 4D0h and 4D1h. These two registers allow the interrupt lines to be programmed as edge or level trigger mode.

4.7.1 Edge/Level Trigger Register for IRQ7 - IRQ3 (I/O address 4D0h)

Bit	R/W	Default	Function
7	W	0	When set to one, IRQ7 will be selected as level sensitive mode. IRQ7 will be selected as edge trigger when set to zero.
6	W	0	When set to one, IRQ6 will be selected as level sensitive mode. IRQ6 will be selected as edge trigger when set to zero.
5	W	0	When set to one, IRQ5 will be selected as level sensitive mode. IRQ5 will be selected as edge trigger when set to zero.
4	W	0	When set to one, IRQ4 will be selected as level sensitive mode. IRQ4 will be selected as edge trigger when set to zero.
3	W	0	When set to one, IRQ3 will be selected as level sensitive mode. IRQ3 will be selected as edge trigger when set to zero.
2-0	W	0	Reserved. Must set to zero.

4.7.2 Edge/Level Trigger Register for IRQ15 - IRQ9 (I/O address 4D1h)

Bit	R/W	Default	Function
7	W	0	When set to one, IRQ15 will be selected as level sensitive mode. IRQ15 will be selected as edge trigger when set to zero.
6	W	0	When set to one, IRQ14 will be selected as level sensitive mode. IRQ14 will be selected as edge trigger when set to zero.
5	W	0	Reserved. Must set to zero.
4	W	0	When set to one, IRQ12 will be selected as level sensitive mode. IRQ12 will be selected as edge trigger when set to zero.
3	W	0	When set to one, IRQ11 will be selected as level sensitive mode. IRQ11 will be selected as edge trigger when set to zero.
2	W	0	When set to one, IRQ10 will be selected as level sensitive mode. IRQ10 will be selected as edge trigger when set to zero.
1	W	0	When set to one, IRQ9 will be selected as level sensitive mode. IRQ9 will be selected as edge trigger when set to zero.
0	W	0	Reserved. Must set to zero.

Section 5.0 2051nt DC Specifications

Rating Specifications

Parameter	Sym.	Condition	Min.	Max.	Unit
Power supply voltage	V _{dd}	T _a = 25° C	V _{ss} - 0.3	7.0	V
Input voltage	V _I		V _{ss} - 0.3	V _{dd} + 0.5	V
Output voltage	V _O		V _{ss} - 0.3	V _{dd} + 0.5	V
Operating temperature	T _{op}		0	70.0	° C
Storage temperature	T _{stg}		-65.0	150.0	° C

Exposing the device to stress above the maximum limits can cause permanent damage. The device is not meant to be operated under conditions outside the limits described in the operational sections of this specification. Exposure to absolute maximum rating conditions for extended periods can adversely affect the device's reliability.

Capacitance Limits

T_A = +25° C, V_{dd} = 5.0V

Parameter	Sym.	Min.	Typ.	Max.	Unit	Test Condition
Input capacitance	C _I		4.0		pF	f _c = 1.0 MHz unmeasured pins at GND.
Output capacitance	C _O		6.0		pF	
I/O capacitance	C _{IO}		10.0		pF	

Power Consumption Specifications

Symbol	Parameter	Fully-On	Suspend
13.3	CLK = 33.3MHz	26.40mA	0.09uA
	CLK = 60MHz	49.0mA	0.10uA
	CLK = 66.6MHz	53.0mA	0.13uA
15.0	CLK = 33.3 MHz	103.0mA	7.3mA
	CLK = 60MHz	163mA	7.6mA
	CLK = 66.6MHz	168.0mA	7.8mA

DC Specifications for 3.3V/5.0V Signals - TA = 0° C to 70° C, Vdd = 3.3V +/- 5% or 5.0V +/- 5%

Signals: GPIO0-2, PCICLK, /REQ0-3, /INTA-/INTD, /SIN, DRQ0-7, IRQ1,IRQ3-11, IRQ14-15, /IOCS16, /MCS16, CLKSRC, 14M, /ZWS, BATLOW0, EXTSMI0-2, /SRBTN, ACPWR, /EXTSYS, IDEDRQ, PWRGD, A3-4, /BE0-7, WR, /HIT-M, DC, /ADS, /LOCK, /SMIACT, /CACHE, MIO, /FERR, CPUCLK, KCLK

Parameter	Sym.	Min.	Max.	Unit	Test Condition
Input low voltage	VIL	Vss	0.8	V	Vdd = 3.3+/- 5% or 5.0 +/- 5%
Input high voltage	VIH	2.0	Vdd	V	Vdd = 3.3+/- 5% or 5.0 +/- 5%
Input low current	IIL	-1.0	1.0	uA	Vin = Vss
Input high current	IIH	-1.0	1.0	uA	Vin = Vdd

Signals: /SMI, INIT, /IGNNE, /STPCLK, /GNT0-3, /SOUT, CPURST, /A20M, INTR, RTCAS, /RTCWR, NMI, KALE, /TAGWE, /BOFF, /KEN, /KWE0-/KWE7, SYSCLK, /DACK0-7, BALE, TC, /SMEMR, /SMEMW, /EADS, /NA, /BRDY, RSTDRV, /XDIR, /ROMCS, SPKR, /RTCD, PWROUT0-1, /IDEDACK, /SUSP

Parameter	Sym.	Min.	Max.	Unit	Test Condition
Output low voltage	VOL		Vss + 0.4	V	IOL = 4.0 mA
Output high voltage	VOH	2.4		V	IOH = -4.0 mA

Signals: /PCIRST, /CAS0-/CAS7, AEN, BALE, /SMEMR, /SMEMW, RSTDRV, /IDEDACK, /KOE, /KCS, /TKA3-4, CPUCLK, PCICLK

Parameter	Sym.	Min.	Max.	Unit	Test Condition
Output low voltage	VOL		Vss + 0.4	V	IOL = 8.0 mA
Output high voltage	VOH	2.4		V	IOH = -8.0 mA

Signals: /RAS0-/RAS4, /WEN, MA1-MA11

Parameter	Sym.	Min.	Max.	Unit	Test Condition
Output low voltage	VOL		Vss + 0.4	V	IOL = 12.0 mA
Output high voltage	VOH	2.4		V	IOH = -12.0 mA

Signals: /SERR, IDSEL, /REQ0-3, /INTA, /INTB, /INTC, /INTD, /FERR

Parameter	Sym.	Min.	Max.	Unit	Test Condition
Input low voltage	VIL	Vss	0.8	V	Vdd = 3.3+/- 5% or 5.0 +/- 5%
Input high voltage	VIH	2.0	Vdd	V	Vdd = 3.3+/- 5% or 5.0 +/- 5%
Input low current	IIL	-105.0	-25.0	uA	Vin = Vss
Input high current	IIH	-1.0	1.0	uA	Vin = Vdd
Output low voltage	VOL		Vss + 0.4	V	IOL = 2.0 mA
Output high voltage	VOH	2.4		V	IOH = -1.0 mA
Tristate leakage current	IOZ	-105.0	-25.0	uA	Vout = Vdd or Vss

Signals: /CLKRUN, IOCHCK, /MASTER, D0-63, MD0-63, /XDIR, /KBCS, KBGA20, /KBRST, SMCLK, SMDATA, IRQ12

Parameter	Sym.	Min.	Max.	Unit	Test Condition
Input low voltage	VIL	Vss	0.8	V	Vdd = 3.3+/- 5% or 5.0 +/- 5%
Input high voltage	VIH	2.0	Vdd	V	Vdd = 3.3+/- 5% or 5.0 +/- 5%
Input low current	IIL	-105.0	-25.0	uA	Vin = Vss
Input high current	IIH	-1.0	1.0	uA	Vin = Vdd
Output low voltage	VOL		Vss + 0.4	V	IOL = 4.0 mA
Output high voltage	VOH	2.4		V	IOH = -1.0 mA
Tristate leakage current	IOZ	-105.0	-25.0	uA	Vout = Vdd or Vss

Signals: AD0-31, PAR, /CBE0-/CBE3, /PCILOCK, /STOP, /DEVSEL, /TRDY, /IRDY, /FRAME, /SERR, SD0-15, /PCIRST, IOCHRDY, SA0-16, /SBHE, LA17-23, /MEMR, /MEMW, REF#/32K, BALE, /IOR, /IOW

Parameter	Sym.	Min.	Max.	Unit	Test Condition
Input low voltage	VIL	Vss	0.8	V	Vdd = 3.3+/- 5% or 5.0 +/- 5%
Input high voltage	VIH	2.0	Vdd	V	Vdd = 3.3+/- 5% or 5.0 +/- 5%
Input low current	IIL	-105.0	-25.0	uA	Vin = Vss
Input high current	IIH	-1.0	1.0	uA	Vin = Vdd
Output low voltage	VOL		Vss + 0.4	V	IOL = 8.0 mA
Output high voltage	VOH	2.4		V	IOH = -4.0 mA
Tristate leakage current	IOZ	-105.0	-25.0	uA	Vout = Vdd or Vss

Section 6.0 2051nt AC Specifications

6.1 Timing Diagrams

Figure 6.1.1 Propagation Delay

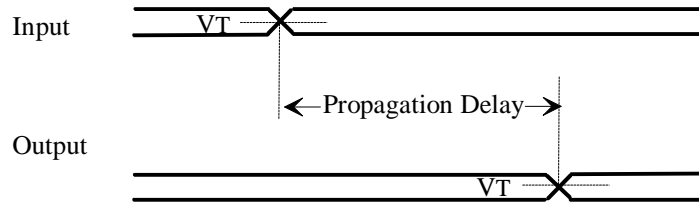

Figure 6.1.2 Valid Delay from Rising Clock Edge

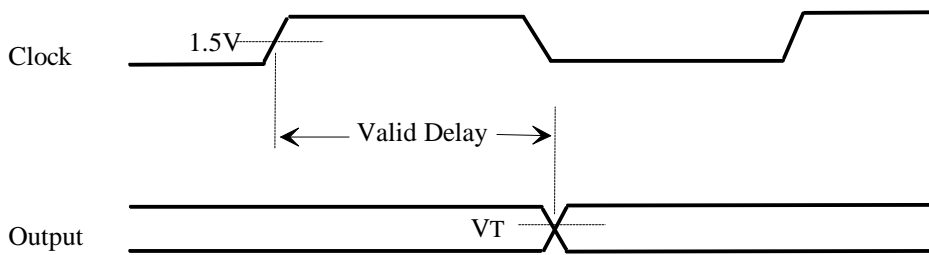

Figure 6.1.3 Setup and Hold Times

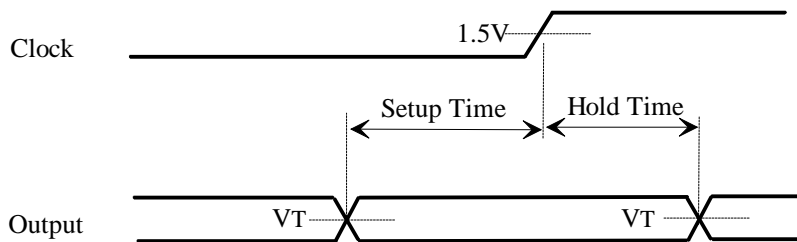

Figure 6.1.4 Float Delay

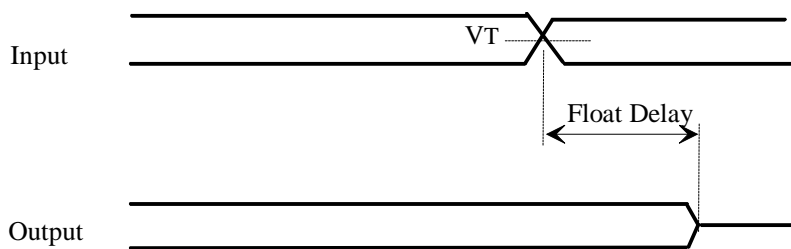

Figure 6.1.5 Clock High and Low Timers and Period

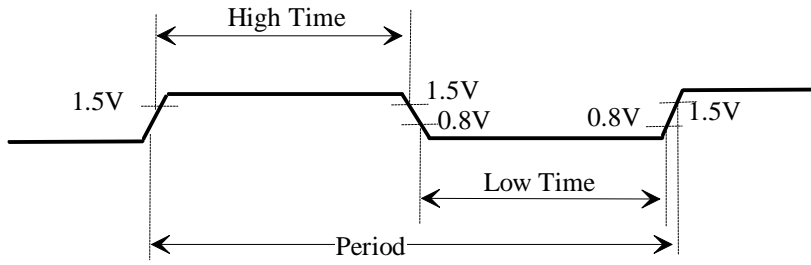

Figure 6.1.6 Pulse Width

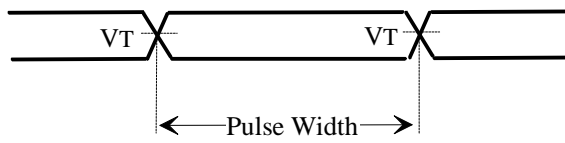
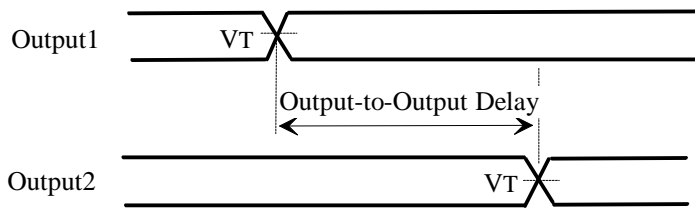

Figure 6.1.7 Output to Output Delay



6.2 Signal Timing

The default load of output is 50 pF unless otherwise specified.

6.2.1 CLOCK Timing (66MHz)

Sym.	Parameter	Min.	Max.	Figure	Remark
	CLKSRC high time	6ns		6.1.5	
	CLKSRC low time	6ns		6.1.5	
	CPUCLKI low time	6ns		6.1.5	
	CPUCLKI high time	6ns		6.1.5	
	PCICLKI high time	12ns		6.1.5	
	PCICLKI low time	12ns		6.1.5	

6.2.2 CPU Interface Timing

Sym.	Parameter	Min.	Max.	Figure	Remark
	/ADS, /HITM, W/-R, M/-IO, D/-C, /CACHE, /BE[0:7], /SMIACT setup time to the rising edge of CPUCLKI	5.10ns		6.1.3	
	/ADS, /HITM, W/-R, M/-IO, D/-C, /CACHE, /BE[0:7], /SMIACT hold time to the rising edge of CPUCLKI	4.80ns		6.1.3	
	/BRDY rising edge valid delay from the rising edge of CPUCLKI	5.41ns	10.83ns	6.1.2	20pF
	/BRDY falling edge valid delay from the rising edge of CPUCLKI	5.52ns	9.37ns	6.1.2	20pF
	/NA valid delay from the rising edge of CPUCLKI	2.31ns	7.90ns	6.1.2	20pF
	/BOFF delay from the rising edge of CPUCLKI	4.70ns	7.60ns	6.1.2	20pF
	/EADS, INV valid delay from the rising edge of CPUCLKI	3.33ns	9.25ns	6.1.2	20pF
	/KEN valid delay from the rising edge of CPUCLKI	2.58ns	7.50ns	6.1.2	20pF

6.2.3 Asynchronous Cache Interface Timing (66MHz)

Sym.	Parameter	Min.	Max.	Figure	Remark
	/KOE rising edge valid delay from rising edge of CPUCLKI	5.39ns	10.06ns	6.1.2	
	/KOE falling edge valid delay from rising edge of CPUCLKI	5.42ns	10.10ns	6.1.2	
	/KWE0-7 rising edge valid delay from falling edge of CPUCLKI	7.76ns	14.08ns	6.1.2	20pF
	/KWE0-7 falling edge valid delay from falling edge of CPUCLKI	4.16ns	12.33ns	6.1.2	20pF
	/KWE0-7 driven high before KALE driven high	7.50ns		6.1.7	
	/TKA3, /TKA4 valid before /KWE0-7 falling	7.70ns		6.1.7	
	/KALE valid delay from the rising edge of CPUCLKI	8.17ns	14.89ns	6.1.2	
	TAGWE rising edge valid delay from falling edge of CPUCLKI	7.30ns	13.28ns	6.1.2	
	TAGWE rising edge valid delay from falling edge of CPUCLK	7.36ns	15.25ns	6.1.2	

6.2.4 Synchronous Cache Interface Timing (66MHz)

Sym.	Parameter	Min.	Max.	Figure	Remark
	/ADSV valid delay from the rising edge of CPUCLKI	5.63ns	10.76ns	6.1.2	
	/ADSC rising edge delay from the rising edge of CPUCLKI	6.11ns	12.09ns	6.1.2	
	/KCS valid delay from the falling edge of /ADS	6.54ns	12.40ns	6.1.2	
	/KWE0-7 valid delay from rising edge of CPUCLKI	4.29ns	11.49ns	6.1.2	20pF
	/KOE falling edge valid delay from rising edge of CPUCLKI	5.39ns	10.10ns	6.1.2	
	/KOE rising edge valid delay from rising edge of CPUCLKI	5.42ns	10.10ns	6.1.2	
	TAGWE rising edge valid delay from falling edge of CPUCLKI	7.30ns	13.26ns	6.1.2	
	TAGWE falling edge valid delay from falling edge of CPUCLKI	7.38ns	14.46ns	6.1.2	

6.2.5 Fast Page Mode / EDO DRAM Interface Timing (66MHz)

Sym.	Parameter	Min.	Max.	Figure	Remark
	/RAS[0:4] valid delay from the rising edge of CPUCLKI	5.35ns	11.0ns	6.1.2	
	/CAS[0:7] valid delay from the rising edge of CPUCLKI	7.12ns	13.60ns	6.1.2	
	/CAS[0:7] invalid delay from the rising edge of CPUCLKI	7.16ns	13.70ns	6.1.2	
	MA[0:10] propagation delay from address	8.63ns	17.10ns	6.1.1	
	MA11 propagation delay from address	13.57ns	25.10ns	6.1.1	
	/WEN valid delay from rising edge of CPUCLKI	5.80ns	9.50ns	6.1.2	
	COLUMN address valid from rising edge of CPUCLKI	6.85ns	13.07ns	6.1.2	

6.2.6 PCI Interface Timing

Sym.	Parameter	Min.	Max.	Figure	Remark
	C/-BE[0:3], /FRAME, /TRDY, /IRDY, STOP, PAR, /DEVSEL, /SERR valid delay from the rising edge of PCICLK	8.90ns	17.25ns	6.1.2	
	C/-BE[0:3], /FRAME, /TRDY, /IRDY, STOP, PAR, /DEVSEL, /SERR float delay from the rising edge of PCICLK	6.47ns	13.37ns	6.1.4	

6.2.7 AT Interface Timing

Sym.	Parameter	Min.	Max.	Figure	Remark
	INIT active delay from rising edge of CPUCLKI	4.5ns	14.7ns	6.1.2	
	INIT active period in software reset and shutdown	15clocks		6.1.5	
	INIT in-active delay from rising edge of CPUCLKI	5.6ns	17.9ns	6.1.2	
	/IOCS16 hold time from the rising edge of SYSCLK	1.0ns	3.0ns	6.1.3	
	/MEMCS16 hold time from the rising edge of SYSCLK (16-bit)	1.0ns	3.0ns	6.1.3	
	/ENABUS active delay from the rising edge of CPUCLKI	34.2ns	44.0ns	6.1.2	
	/ENABUS in-active delay from the rising edge of CPUCLKI	21.0ns	24.2ns	6.1.2	
	/MEMR, /MEMW active delay from the rising edge of SYSCLK (16-bit)	3.9ns	12.4ns	6.1.2	
	/IOW, /IOR active delay from the rising edge of SYSCLK (16-bit)	1.0ns	3.2ns	6.1.2	
	/MEMR, /MEMW, /IOR, /IOW in-active delay from the rising edge of SYSCLK (16-bit)	1.2ns	3.4ns	6.1.2	
	/BRDY active delay from the rising edge of CPUCLKI	4.5ns	14.0ns	6.1.2	
	/BRDY in-active delay from the rising edge of CPUCLKI	4.5ns	14.0ns	6.1.2	
	/IOW, /IOR active delay from the rising edge of SYSCLK (8-bit)	1.0ns	2.5ns	6.1.2	
	/IOW, /IOR, /MEMW, /MEMR in-active delay from the rising edge of SYSCLK (8-bit)	1.2ns	33.0ns	6.1.2	
	/SMEMR, /SMEMW active delay from the rising edge of SYSCLK (8-bit)	3.2ns	11.3ns	6.1.2	
	/SMEMR, /SMEMW in-active delay from the rising edge of SYSCLK (8-bit)	3.5ns	12.0ns	6.1.2	

6.3 Functional Timing Diagram

6.3.1 Reset Timing

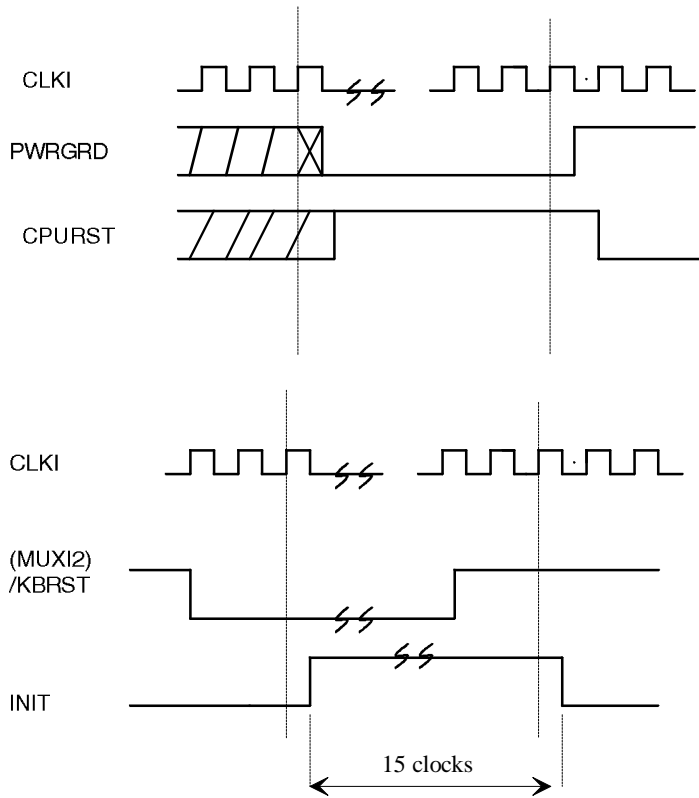

6.3.2 Shutdown Timing

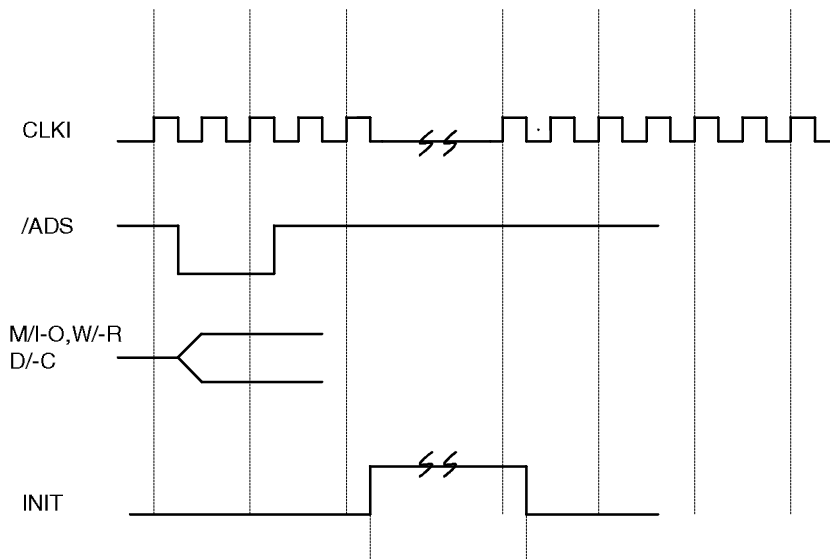

6.3.3 AT Bus 16 Bit Access Timing

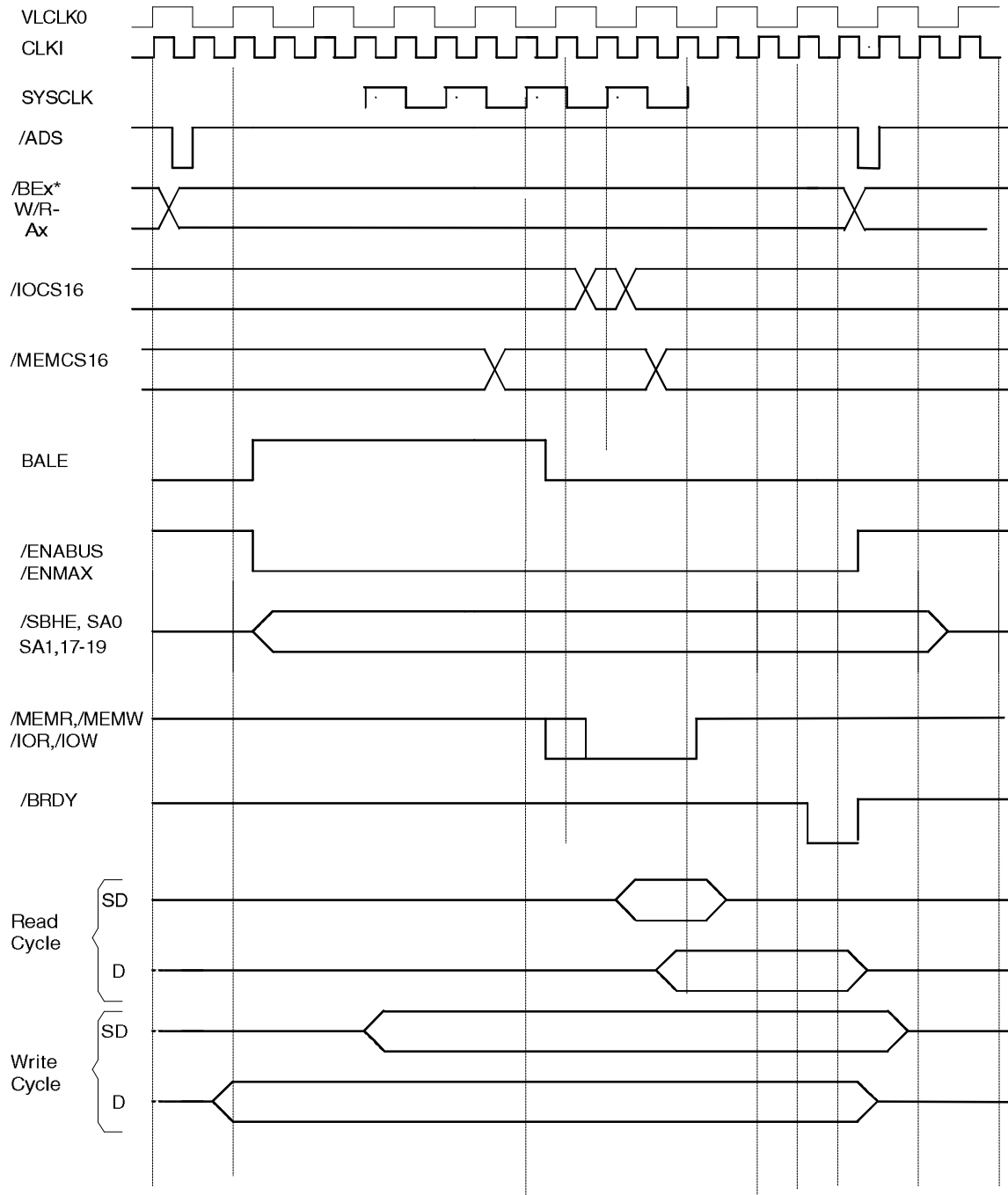

*/BEx indicates /BE0, /BE1, /BE2, and /BE3, /BE4, /BE5, /BE6, /BE7.

6.3.4 AT Bus 8-Bit Access Timing

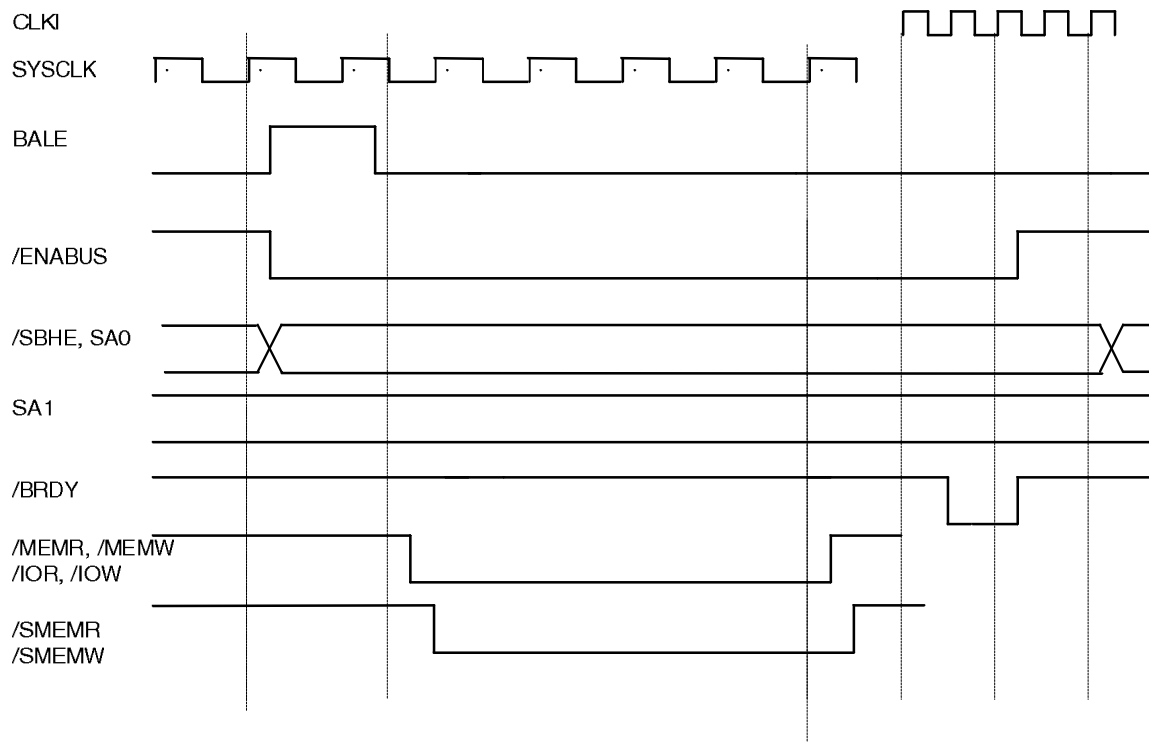

6.3.5 Fast Page Mode DRAM Access Timing - Read Cycle

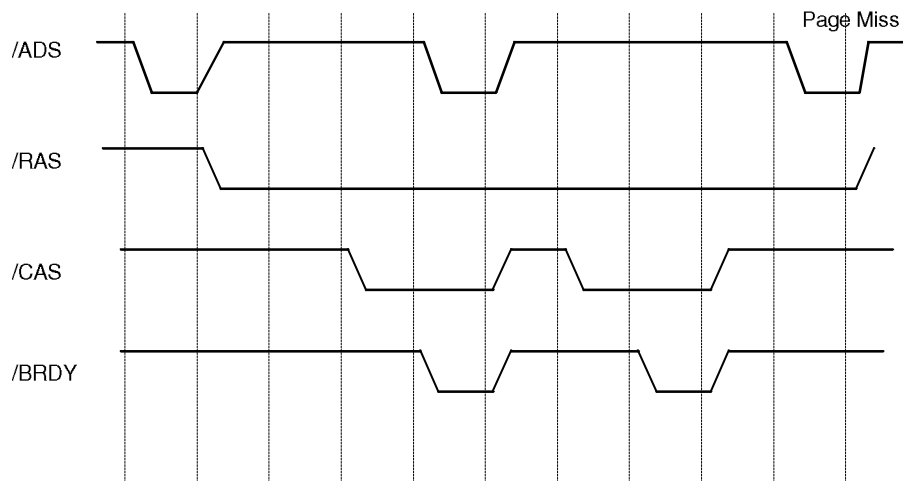

6.3.6 Fast Page Mode Access Timing - Write Cycle

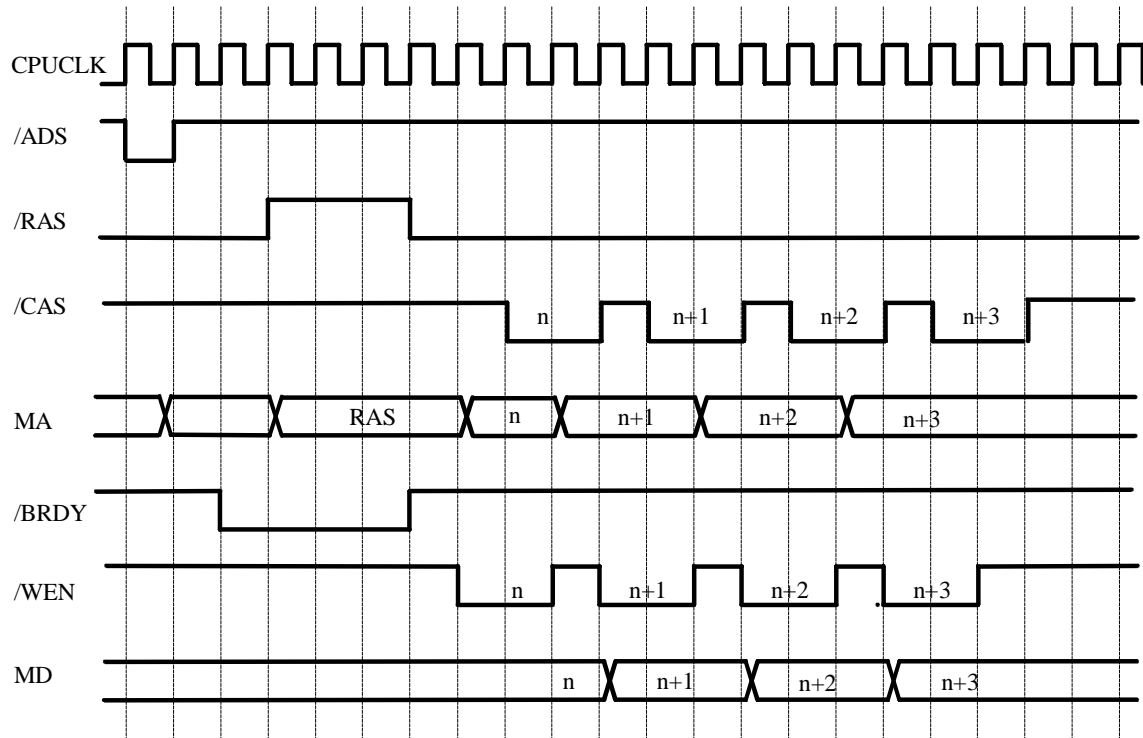

6.3.7 EDO Page Write Missed Cycle Timing

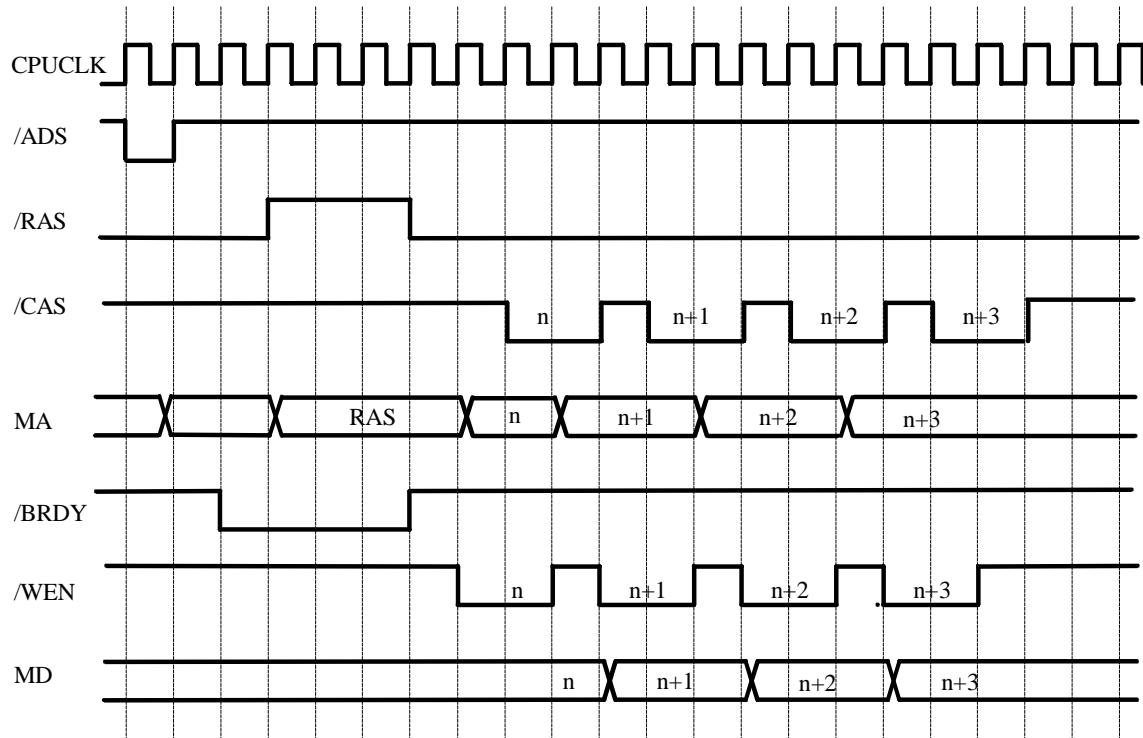

6.3.8 EDO Page Read Missed Cycle Timing

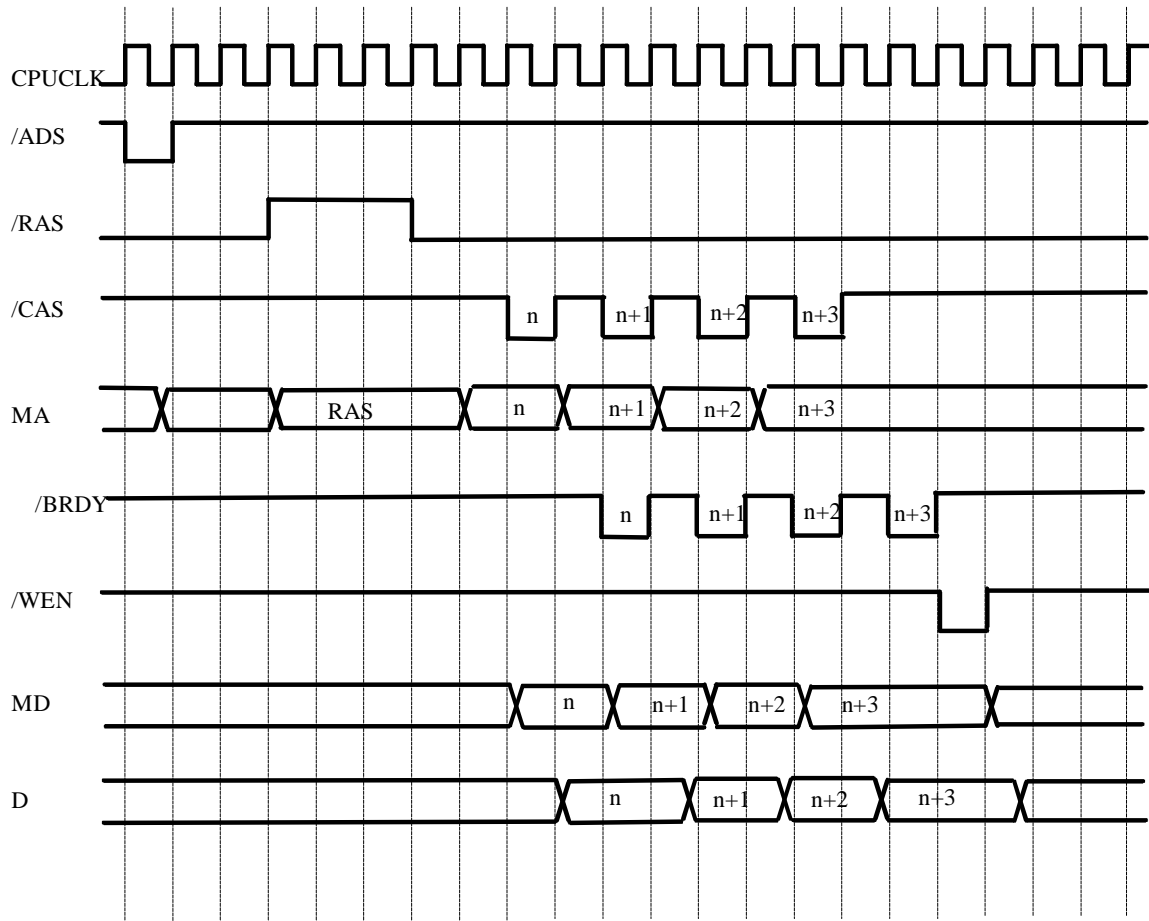

6.3.9 Asynchronous SRAM Burst Read Cycle (3-2-2-2)

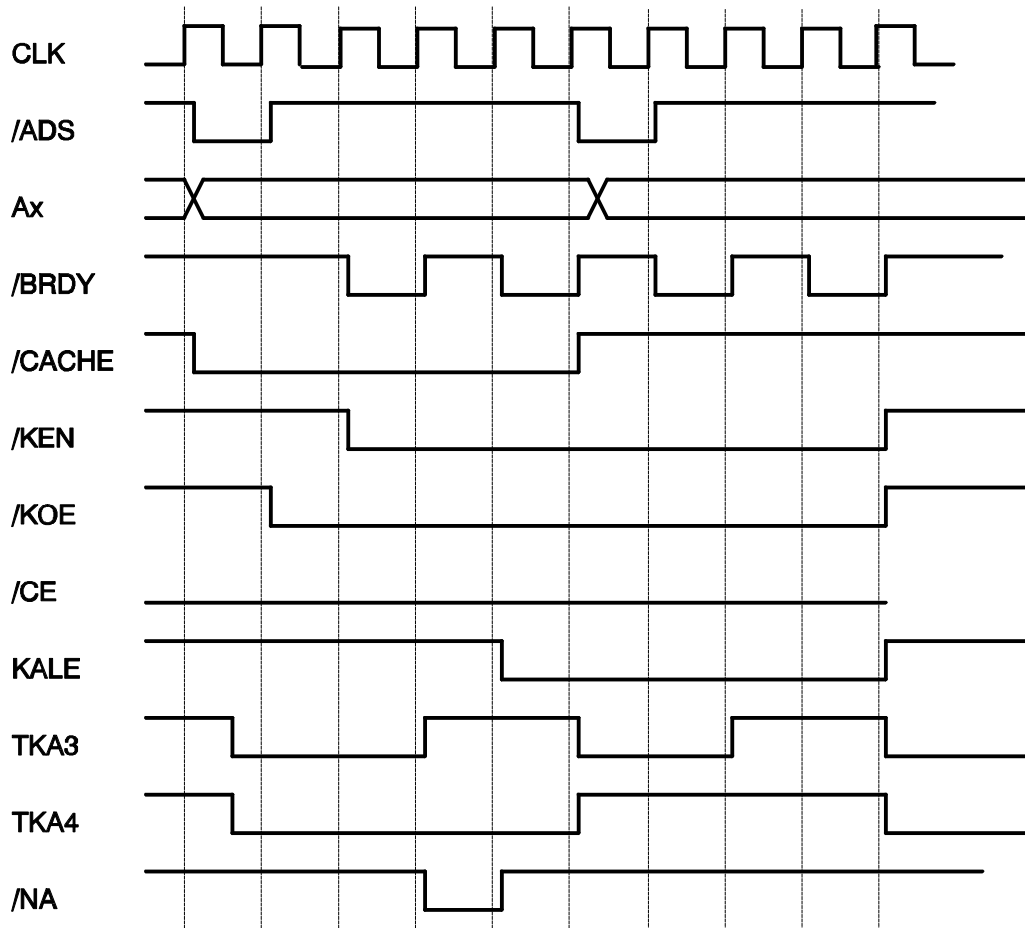

6.3.10 Asynchronous SRAM Burst Write Cycle (4-2-2-2)

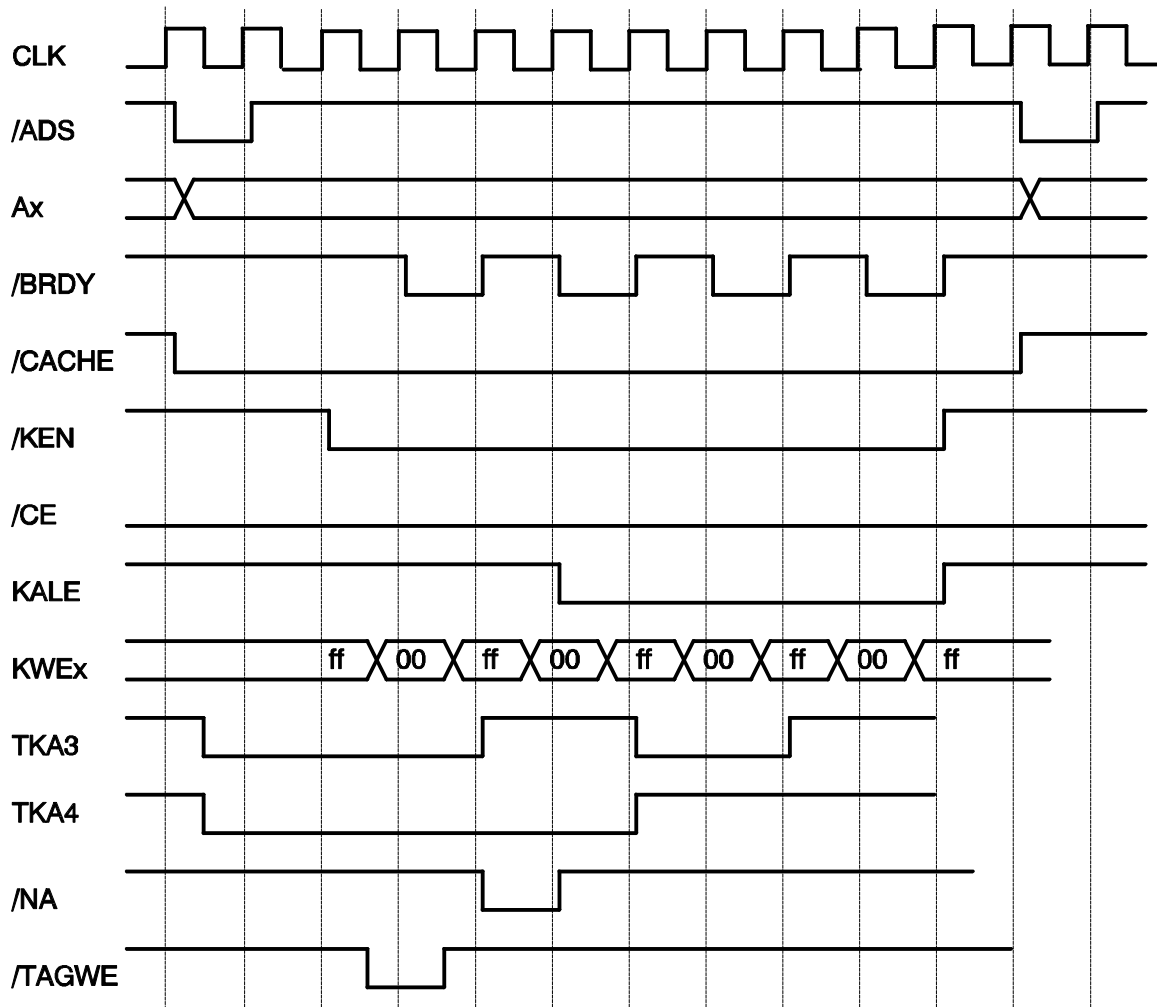

6.3.11 Pipeline Synchronous SRAM Burst Read Cycle

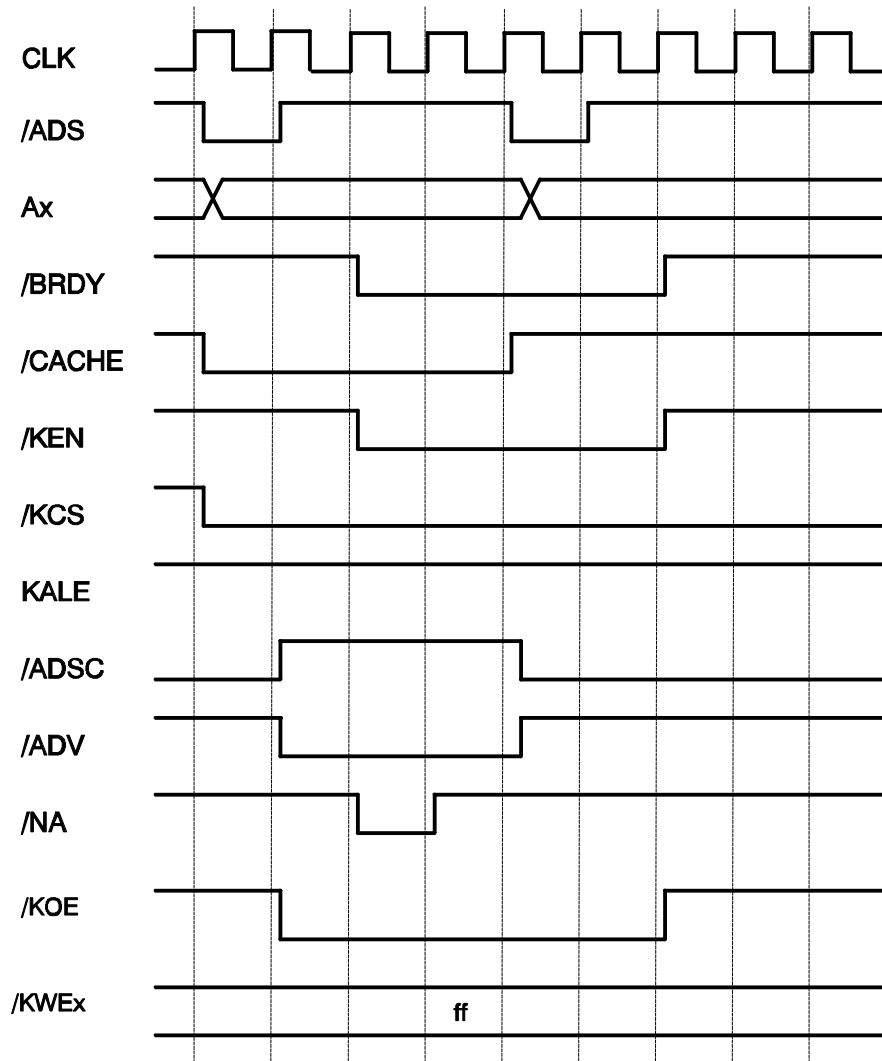

*Note: For synchronous SRAM, use /KCS.

6.3.12 Pipeline Synchronous SRAM Burst Write Cycle (3-1-1-1)

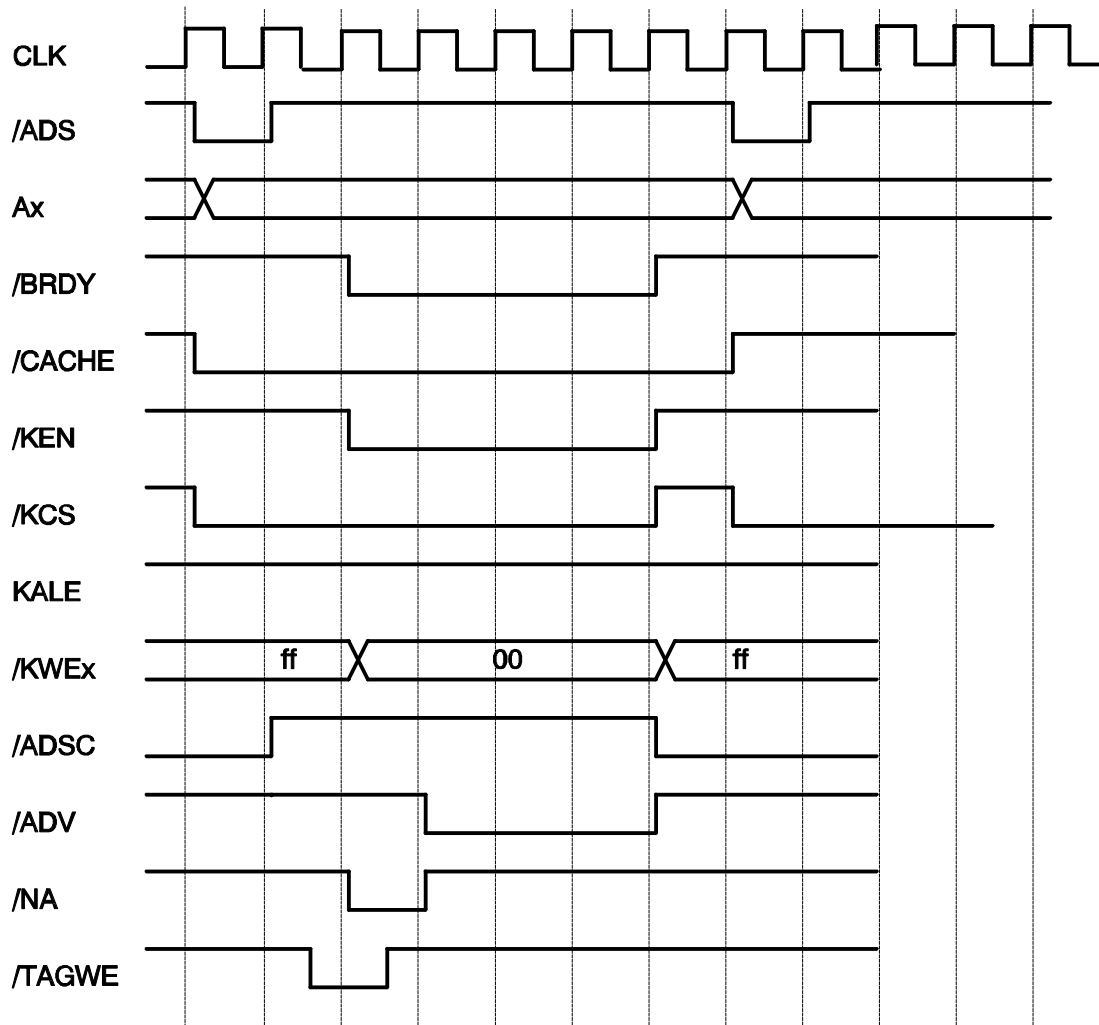

*Note: For synchronous SRAM, use /KCS.

6.3.13 CPU to PCI Single Read

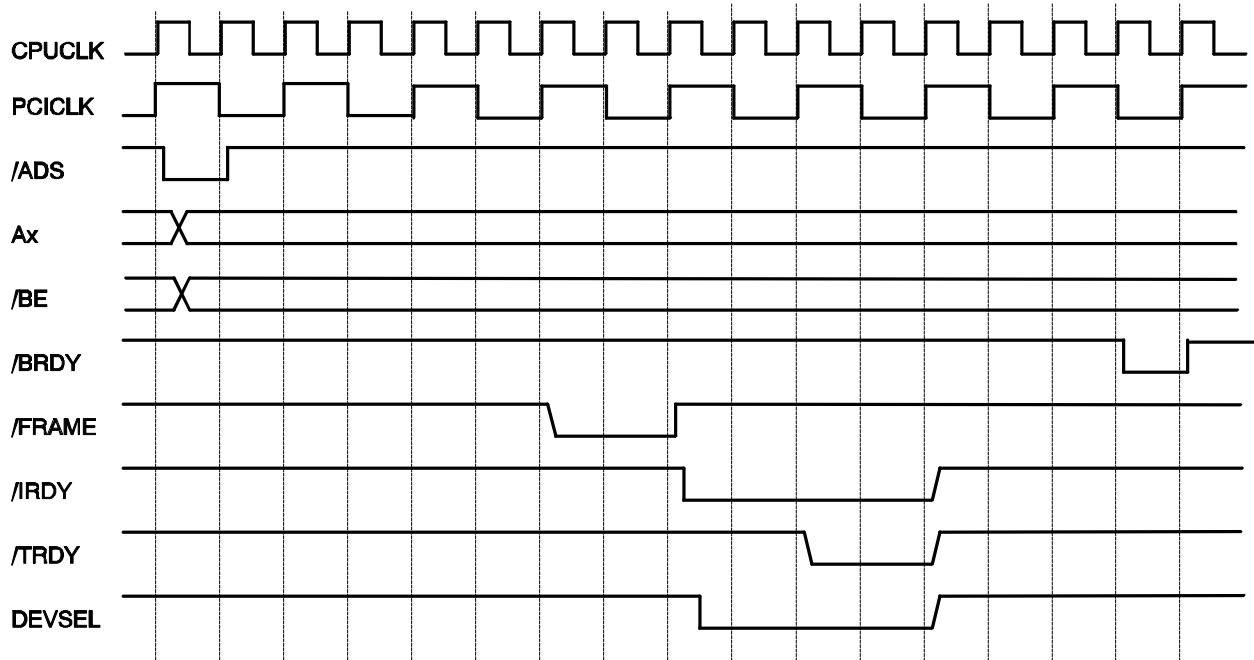

6.3.14 CPU to PCI Single Write, Write to Buffer

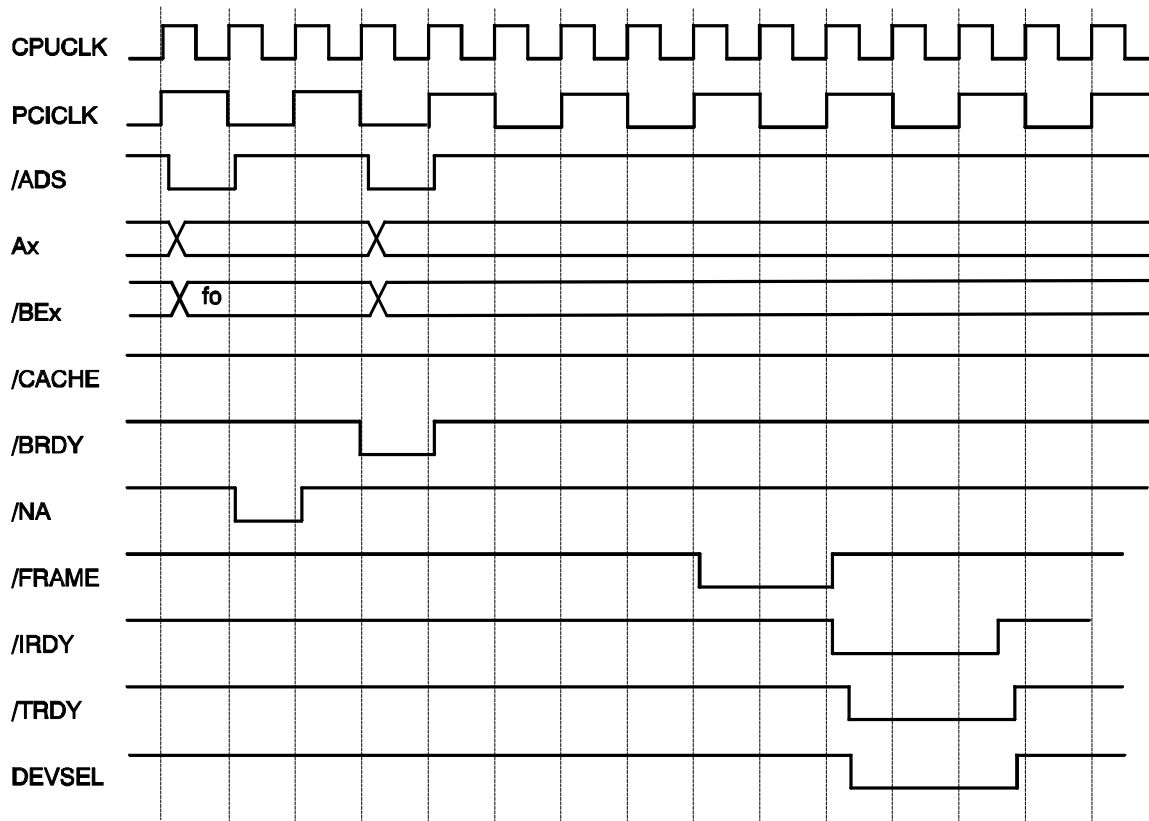

6.3.15 CPU to PCI Multiple Write, Write to Buffer, PCI Burst Write

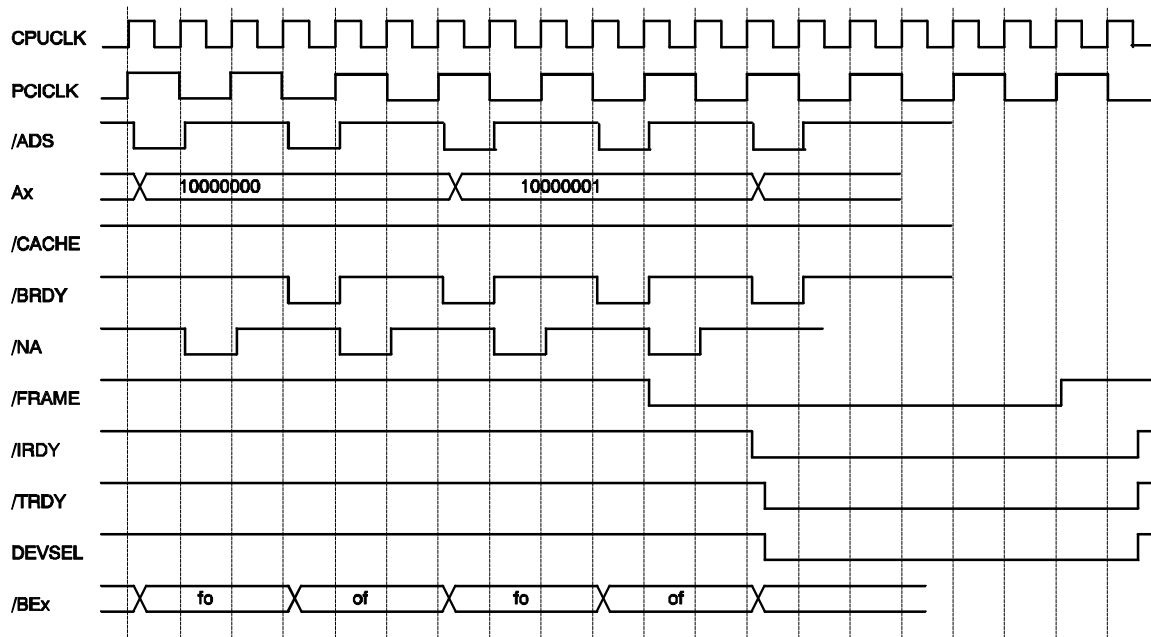

Section 7.0 2051nt Pin-out Diagram and Mechanical Data

7.1.1 Pin Side View

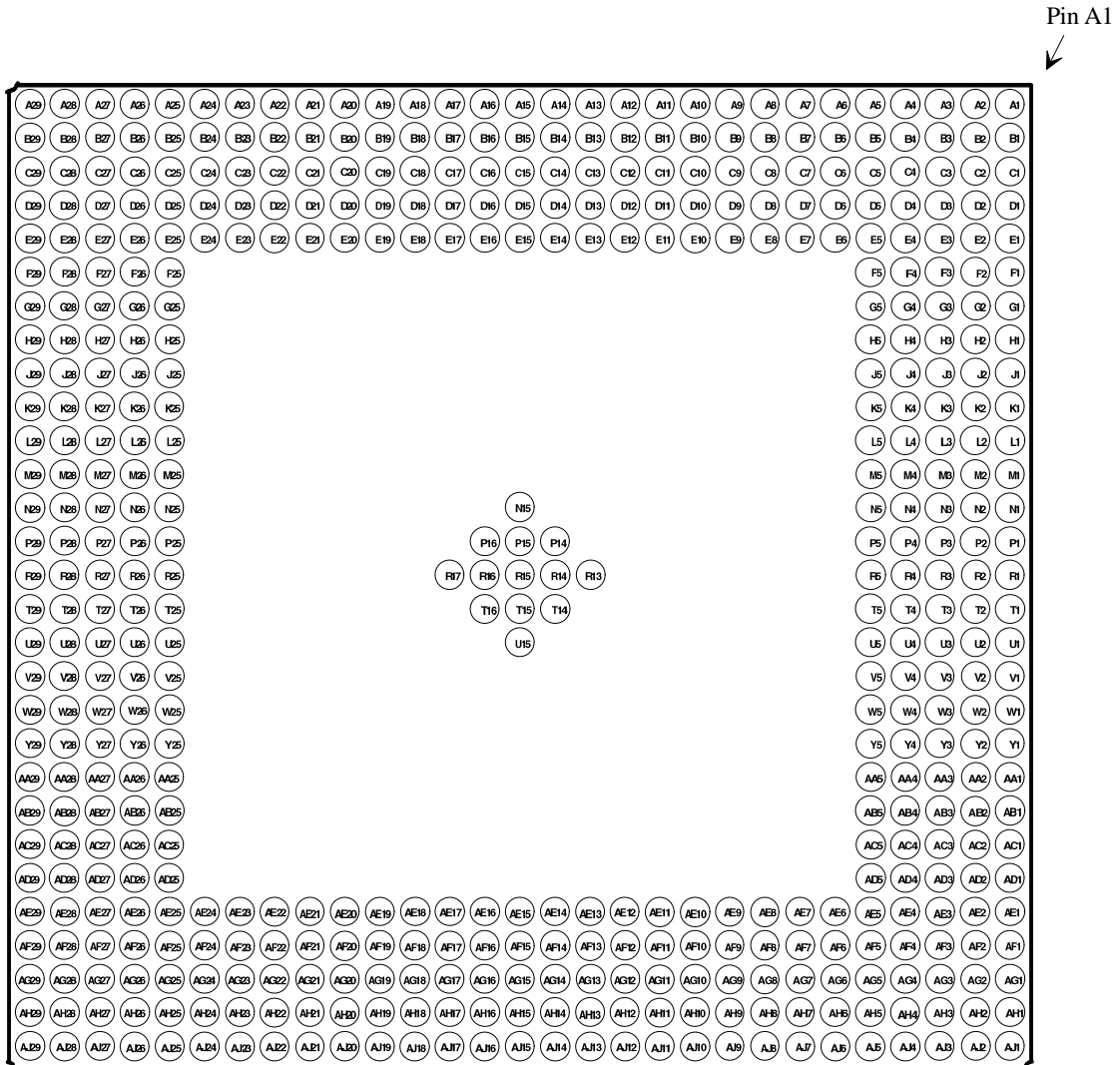

7.1.2 Top View

Pin A1

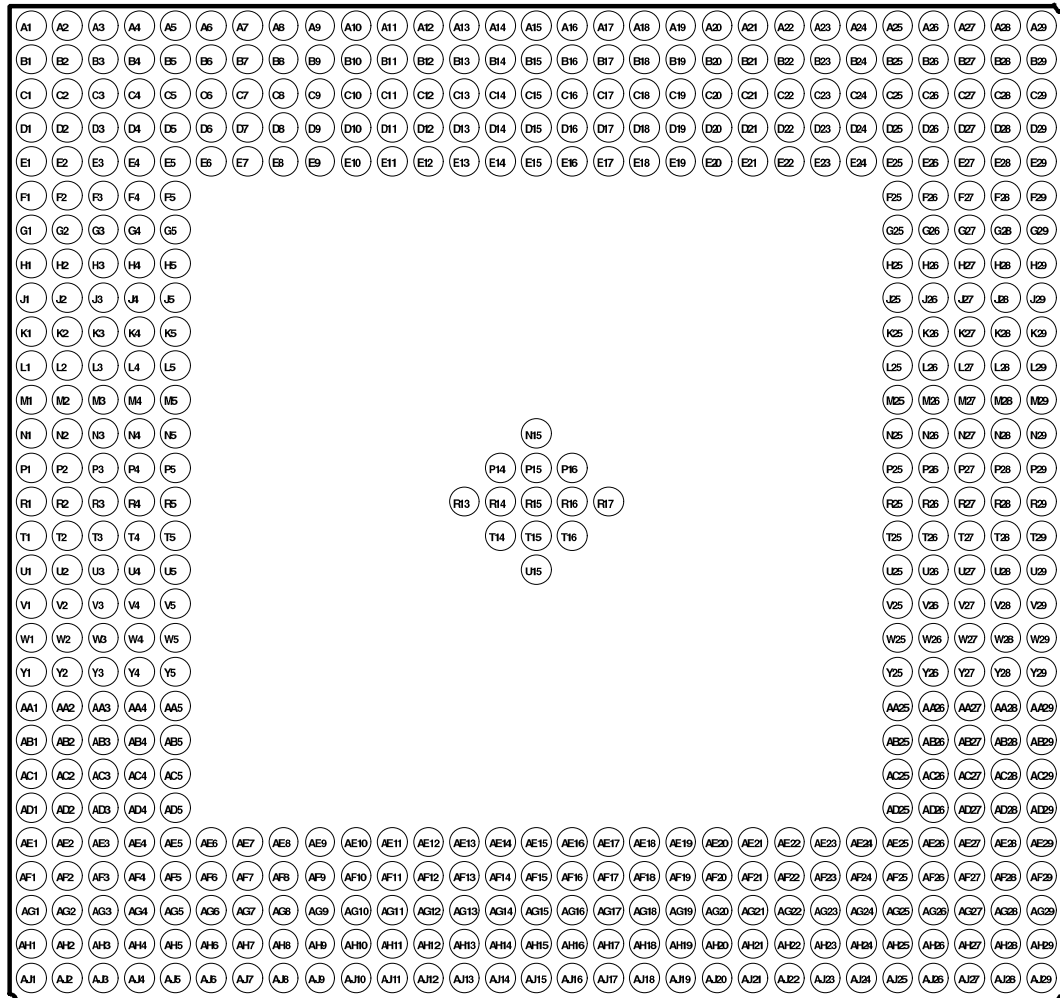

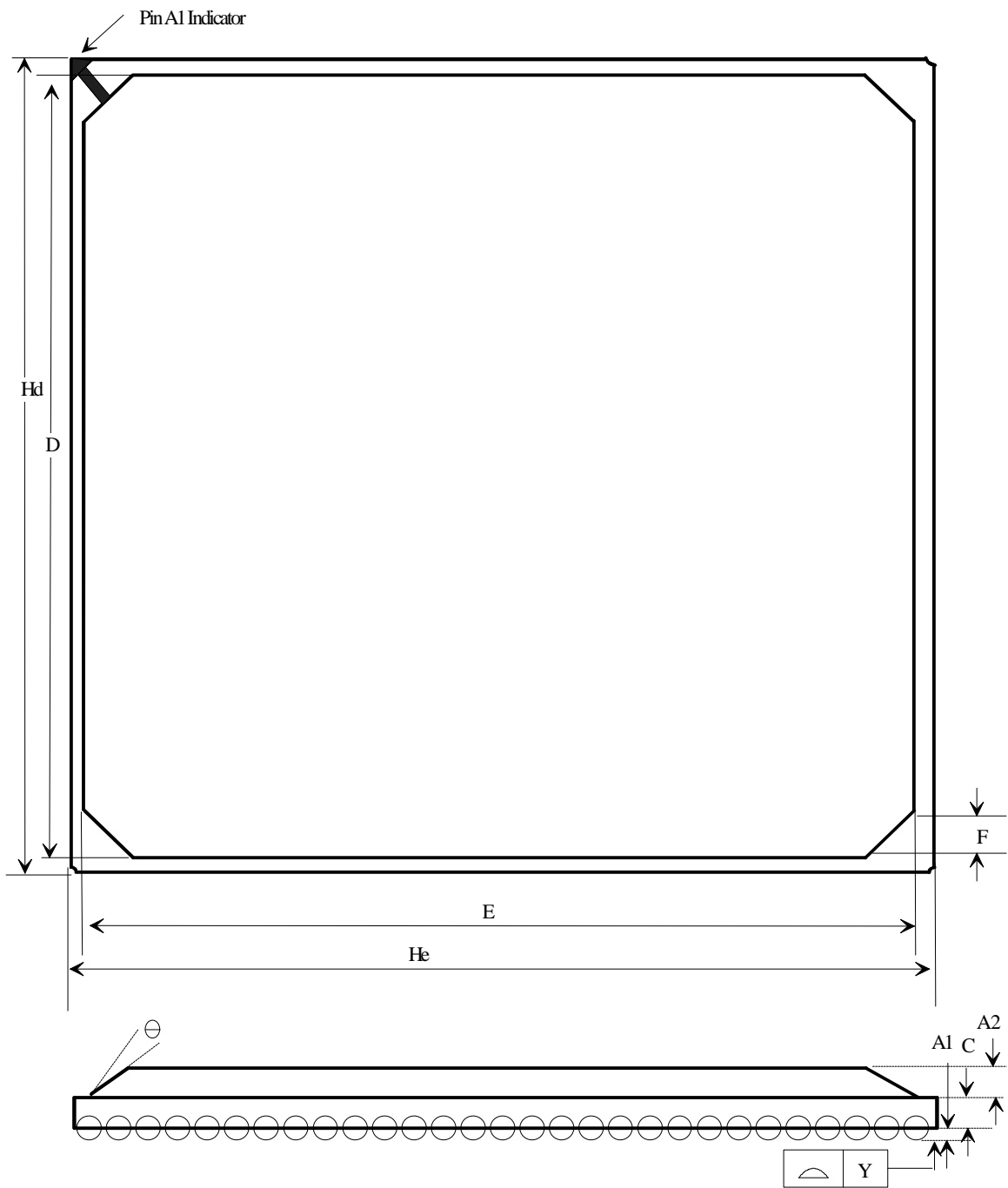

The “top view” of the pin diagram above is the view of the ACC Micro 2051nt pin locations as if they could be looked through from the top of the molding/PCB substrate.

7.1.3 Mechanical Data - Top View and Side View

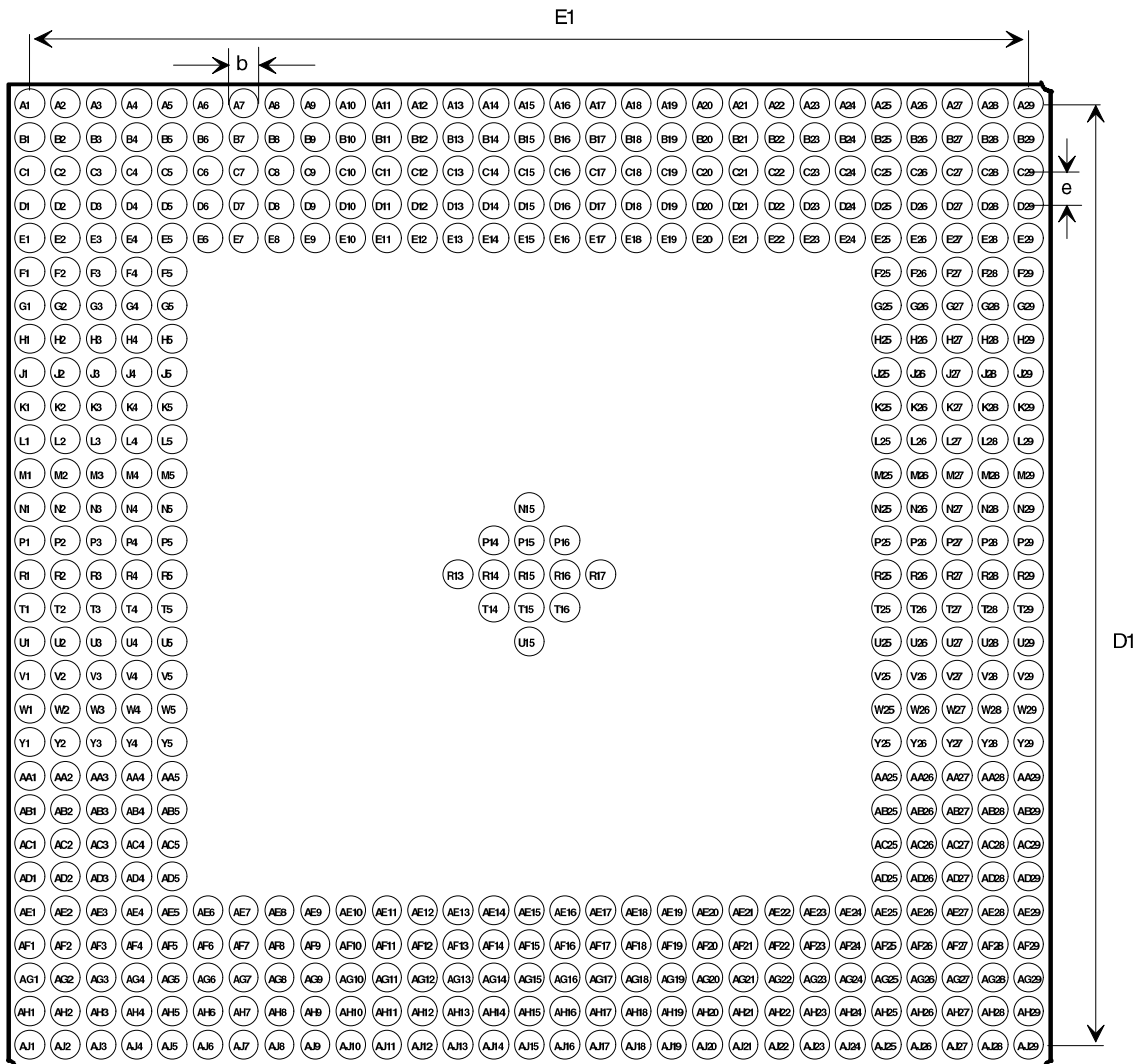

7.1.4 Mechanical Data - Top View



The “top side view” of the pin diagram above is the view of the ACC Micro 2051nt pin locations as if they could be looked through from the top of the molding/PCB substrate.

7.1.5 Package Dimensions

Symbol	Minimum	Typical	Maximum
A1	0.55 mm	0.60 mm	0.65 mm
A2	1.12 mm	1.17 mm	1.22 mm
b	0.60 mm	0.75 mm	0.90 mm
C	0.51 mm	0.56 mm	0.61 mm
D	34.30 mm	34.50 mm	34.70 mm
D1	35.36 mm	35.56 mm	35.76 mm
E	34.30 mm	34.50 mm	34.70 mm
E1	35.36 mm	35.56 mm	35.76 mm
F		4.6*45° (4X)	
e		1.27 mm	
Hd	37.30 mm	37.50 mm	37.70 mm
He	37.30 mm	37.50 mm	37.70 mm
θ	23°	30°	37°
Y			0.15 mm



ACC Microelectronics Headquarters

ACC Microelectronics Corporation
2500 Augustine Drive,
Santa Clara, CA 95054
Phone: (408) 980-0622
Fax: (408) 980-0626

International Sales

Taiwan

ACC Taiwan Inc.
10-2 FL., No.77. Sec.4,
Nan-King E. Rd.,
Taipei, Taiwan, R.O.C.
Phone: (02) 719-9076
Fax: (02) 514-9127

Seper Technology Corp.
4th Fl., 75 Sec. 3,
Ming-Sheng E. Rd.,
Taipei, Taiwan, R.O.C.
Phone: (02) 506-3320
Fax: (02) 504-8081

Yosun Industrial Corporation
7F, No. 76, Sec. 1, Cheng Kung Road
Nan Kang, Taipei, Taiwan
Phone: (02) 788-1991
Fax: (02) 788-1996

Japan

Nippon IMEX Corp.
1-46-9 Matsubara
Setagaya-Ku
Tokyo, 156 Japan
Phone: (33) 321-8000
Fax: (33) 325-0021

Korea

Intellect, Inc.
Sonam Bldg. 3F, 1001-4,
Dacchi-dong, Kangnam-Ku
Seoul, Korea
Phone: (2) 568-0501
Fax: (2) 558-0444

Connecticut

Dynamic Sales
24 Ray Avenue
Burlington, MA 01803
Phone: (617) 272-5676
Fax: (617) 273-4856

Maine

Dynamic Sales
24 Ray Avenue
Burlington, MA 01803
Phone: (617) 272-5676
Fax: (617) 273-4856

Massachusetts

Dynamic Sales
24 Ray Avenue
Burlington, MA 01803
Phone: (617) 272-5676
Fax: (617) 273-4856

Minnesota

D.A. Case Associates, Inc.
4620 West 77th Street #250
Minneapolis, MN 55435
Phone: (612) 831-6777
Fax: (612) 831-7076

New Hampshire

Dynamic Sales
24 Ray Avenue
Burlington, MA 01803
Phone: (617) 272-5676
Fax: (617) 273-4856

North Dakota

D.A. Case Associates, Inc.
4620 West 77th Street #250
Minneapolis, MN 55435
Phone: (612) 831-6777
Fax: (612) 831-7076



contd...

Rhode Island

Dynamic Sales
24 Ray Avenue
Burlington, MA 01803
Phone: (617) 272-5676
Fax: (617) 273-4856

Vermont

Dynamic Sales
24 Ray Avenue
Burlington, MA 01803
Phone: (617) 272-5676
Fax: (617) 273-4856

South Dakota

D.A. Case Associates, Inc.
4620 West 77th Street #250
Minneapolis, MN 55435
Phone: (612) 831-6777
Fax: (612) 831-7076

Wisconsin (Western)

D.A. Case Associates, Inc.
4620 West 77th Street #250
Minneapolis, MN 55435
Phone: (612) 831-6777
Fax: (612) 831-7076